



Dell Precision™ Mobile Workstation M90 User's Guide

[Finding Information](#)
[About Your Computer](#)
[Transferring Information to a New Computer](#)
[Using a Battery](#)
[Using the Keyboard and Touch Pad](#)
[Using the Display](#)
[Using Multimedia](#)
[Using Networks](#)
[Using Cards](#)
[Securing Your Computer](#)

[Troubleshooting](#)
[System Setup Program](#)
[Reinstalling Software](#)
[Adding and Replacing Parts](#)
[Dell™ QuickSet](#)
[Traveling With Your Computer](#)
[Getting Help](#)
[Specifications](#)
[Appendix](#)
[Glossary](#)

-  **NOTE:** A NOTE indicates important information that helps you make better use of your computer.
-  **NOTICE:** A NOTICE indicates either potential damage to hardware or loss of data and tells you how to avoid the problem.
-  **CAUTION:** A CAUTION indicates a potential for property damage, personal injury, or death.

For a complete list of abbreviations and acronyms, see [Glossary](#).

If you purchased a Dell™ n Series computer, any references in this document to Microsoft® Windows® operating systems are not applicable.

Information in this document is subject to change without notice.
© 2006 Dell Inc. All rights reserved.

Reproduction in any manner whatsoever without the written permission of Dell Inc. is strictly forbidden.

Trademarks used in this text: *Dell*, the *DELL* logo, *Inspiron*, *Dell Precision*, *Dimension*, *OptiPlex*, *Latitude*, *PowerEdge*, *PowerConnect*, *PowerVault*, *PowerApp*, *Dell TravelLite*, *ExpressCharge*, *Undock & Go*, and *Strike Zone* are trademarks of Dell Inc.; *Intel* is a registered trademark and *Core* is a trademark of Intel Corporation; *Microsoft*, *Outlook*, and *Windows* are registered trademarks of Microsoft Corporation; *Bluetooth* is a registered trademark owned by Bluetooth SIG, Inc. and is used by Dell under license; *EMC* is a registered trademark of EMC Corporation; *ENERGY STAR* is a registered trademark of the U.S. Environmental Protection Agency.

Other trademarks and trade names may be used in this document to refer to either the entities claiming the marks and names or their products. Dell Inc. disclaims any proprietary interest in trademarks and trade names other than its own.

Model PP05XA

January 2006 P/N ND244 Rev. A00

About Your Computer

Dell Precision™ M90 User's Guide

- [Determining Your Computer's Configuration](#)
- [Front View](#)
- [Left Side View](#)
- [Right Side View](#)
- [Back View](#)
- [Bottom View](#)

Determining Your Computer's Configuration

Based on selections that you made when purchasing your computer, your computer has one of several different video controller configurations. To determine your computer's video controller configuration:

1. Access the Windows Help and Support Center. For instructions, see [Windows Help and Support Center](#).
2. Under **Pick a Task**, click **Use Tools to view your computer information and diagnose problems**.
3. Under **My Computer Information**, select **Hardware**.

From the **My Computer Information - Hardware** screen, you can view the type of video controller installed in your computer, as well as the other hardware components.

Front View

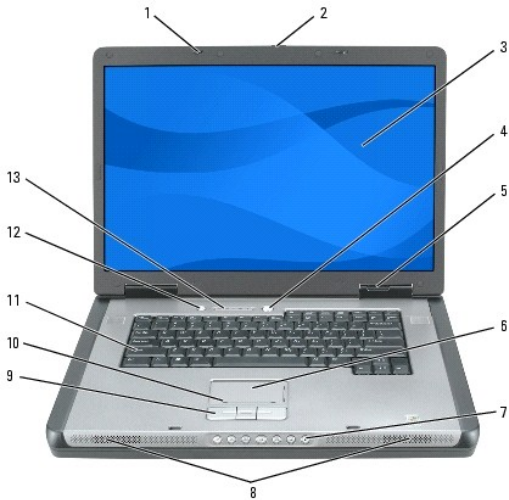

1	display latches (2)	6	touch pad	11	keyboard
2	display latch release	7	media control buttons	12	media button
3	display	8	speakers (2)	13	keyboard and wireless status lights
4	power button	9	touch pad buttons		
5	device status lights	10	touch-pad scroll zone		

display latches — Keeps the display closed.





display latch release — Slide to release the display latches and open the display.

display — For more information about your display, see [Using the Display](#).

power button — Press to turn on the computer or to enter or exit a power management mode. For more information on power management modes, see [Power Management Modes](#).

device status lights



	Turns on when you turn on the computer, and blinks when the computer is in a power management mode.
	Turns on when the computer reads or writes data.  NOTICE: To avoid loss of data, never turn off the computer while the  light is flashing.
	Turns on steadily or blinks to indicate battery charge status.

If the computer is connected to an electrical outlet, the  light operates as follows:

- 1 Solid green: The battery is charging.
- 1 Flashing green: The battery is almost fully charged.

If the computer is running on a battery, the  light operates as follows:





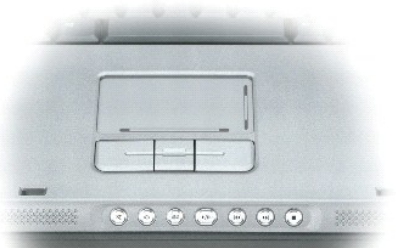

- 1 Off: The battery is adequately charged (or the computer is turned off).
- 1 Flashing orange: The battery charge is low.
- 1 Solid orange: The battery charge is critically low.

touch pad — Provides the functionality of a mouse.

touch-pad scroll zone — Provides the functionality of the scroll button on a mouse. A vertical scroll zone is located on the right side of the touch pad. A horizontal scroll zone is located on the bottom of the touch pad.

media control buttons — Control CD, DVD, and Media Player playback.



	Mute the sound.
	Turn the volume down.
	Turn the volume up.
	Play or pause.
	Play the previous track.
	Play the next track.
	Stop.

speakers — To adjust the volume of the integrated speakers, press the media control buttons or speaker-volume keyboard shortcuts. For more information, see [Speaker Functions](#).

touch pad buttons — Touch pad buttons provide the same functionality as mouse buttons.





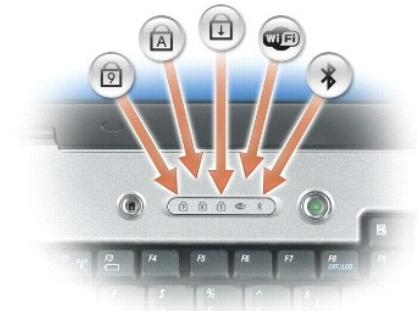

keyboard — The keyboard includes a numeric keypad as well as the Microsoft Windows logo key. For information on supported keyboard shortcuts, see [Key Combinations](#).

media button — Press the media button to launch the software for the media player, if your computer has a media player.

keyboard and wireless status lights



The lights located above the keyboard indicate the following:

	Turns on when the numeric keypad is enabled.
	Turns on when the uppercase letter function is enabled.
	Turns on when the scroll lock function is enabled.
	Turns on when wireless networking is enabled. To quickly enable or disable wireless networking, press <Fn><F2>.
	Turns on when a card with Bluetooth® wireless technology is enabled. NOTE: The card with Bluetooth wireless technology is an optional feature, so the  light turns on only if you ordered the card with your computer. For more information, see the documentation that came with your card. To turn off only the Bluetooth wireless technology functionality, right-click the  icon in the Windows taskbar (in the lower-right corner of your screen) and click Disable Bluetooth Radio . To quickly enable or disable all wireless devices, press <Fn><F2>.

Left Side View



1	security cable slot	3	USB connectors (2)	5	optical-drive-tray eject button
2	air vent	4	optical drive		

security cable slot — Lets you attach a commercially available antitheft device to the computer. For more information, see [Security Cable Lock](#).

air vent — The computer uses fan(s) to create airflow through the vent(s), which prevents the computer from overheating.

CAUTION: Do not block, push objects into, or allow dust to accumulate in the air vents. Do not store your computer in a low-airflow environment, such as a closed briefcase, while it is running. Restricting the airflow can damage the computer or cause a fire.

USB connectors — Connect USB devices, such as a mouse, keyboard, or printer. You can also connect the optional floppy drive directly to a USB connector using the optional floppy-drive cable.

optical drive — You can install devices such as a DVD drive or other optical drive in the optical drive bay. For more information, see [Optical Drive](#).

optical-drive-tray eject button — Press this button to eject a CD or DVD from the optical drive. This button only works when the computer is turned on.

Right Side View



1	smart card slot	4	IEEE 1394 connector	7	air vent
2	hard drive	5	5-in-1 media memory card reader		
3	ExpressCard slot	6	audio connectors (2)		

smart card slot — Supports one smart card. See [Smart Cards](#).

hard drive — Stores software and data.

ExpressCard slot — Supports one ExpressCard, such as a modem or network adapter. The computer ships with a plastic blank installed in the slot. For more information, see [Using Cards](#).

NOTE: The ExpressCard slot does not support PC cards.



IEEE 1394 connector — Connects devices supporting IEEE 1394 high-speed transfer rates, such as some digital video cameras.

5-in-1 media memory card reader — Provides a fast and convenient way to view and share digital photos, music, and videos stored on a media memory card. The 5-in-1 media memory card reader reads the following digital media memory cards:

- o Secure Digital (SD) card/SDIO
- o MultiMediaCard (MMC)
- o Memory Stick
- o Memory Stick PRO
- o xD-Picture Card

audio connectors



Attach headphones or speakers to the  connector.
Attach a microphone to the  connector.

air vent — The computer uses fan(s) to create airflow through the vent(s), which prevents the computer from overheating.

⚠ CAUTION: Do not block, push objects into, or allow dust to accumulate in the air vents. Do not store your computer in a low-airflow environment, such as a closed briefcase, while it is running. Restricting the airflow can damage the computer or cause a fire.

Back View

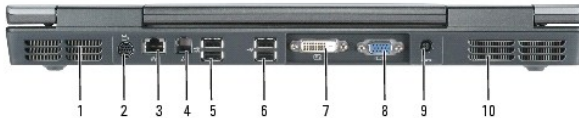

1	air vent	5	USB connectors (2)	9	AC adapter connector
2	S-video TV-out connector	6	USB connectors (2)	10	air vent
3	network (RJ-45) connector	7	Digital-Video Interface (DVI) connector		
4	modem (RJ-11) connector	8	video (VGA) connector		

air vent — The computer uses fan(s) to create airflow through the vents, which prevents the computer from overheating.

⚠ CAUTION: Do not block, push objects into, or allow dust to accumulate in the air vents. Do not store your computer in a low-airflow environment, such as a closed briefcase, while it is running. Restricting the airflow can damage the computer or cause a fire.

S-video TV-out connector

	Connects your computer to a TV. Also connects digital audio capable devices using the TV/digital audio adapter cable.
---	---

network connector (RJ-45)

➡ **NOTICE:** The network connector is slightly larger than the modem connector. To avoid damaging the computer, do not plug a telephone line into the network connector.

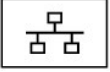
	<p>Connects the computer to a network. The solid light on the connector provides link status information. Off indicates no link, green indicates a 10-Mb/sec link, orange indicates a 100-Mb/sec link, and yellow indicates a 1000-Mb/sec link. The blinking yellow light on the connector indicates activity on the wired network connection.</p> <p>For information on using the network adapter, see the network adapter documentation supplied with your computer under the Windows Help and Support Center. To access the Help and Support Center, see Windows Help and Support Center.</p>
---	--

modem connector (RJ-11)

	<p>To use the internal modem, connect the telephone line to the modem connector.</p> <p>For additional information on using the modem, see the modem documentation supplied with your computer under the Windows Help and Support Center. To access the Help and Support Center, see Windows Help and Support Center.</p>
---	---

USB connectors

	<p>Connect USB devices, such as a mouse, keyboard, or printer.</p>
---	--

digital-video interface (DVI) connector

	<p>Connects an external DVI-compatible monitor, such as a flat-panel monitor. With an adapter cable, you can also connect an external VGA-compatible monitor to the DVI connector.</p>
--	--

video connector

	<p>Connects an external VGA-compatible monitor.</p>
---	---

AC adapter connector — Attaches an AC adapter to the computer.



The AC adapter converts AC power to the DC power required by the computer. You can connect the AC adapter with your computer turned either on or off. For optimum performance, use only the AC adapter that came with your computer.

⚠ **CAUTION:** The AC adapter works with electrical outlets worldwide. However, power connectors and power strips vary among countries. Using an incompatible cable or improperly connecting the cable to the power strip or electrical outlet may cause fire or equipment damage.

➡ **NOTICE:** When you disconnect the AC adapter cable from the computer, grasp the connector, not the cable itself, and pull firmly but gently to avoid damaging the cable.

Bottom View

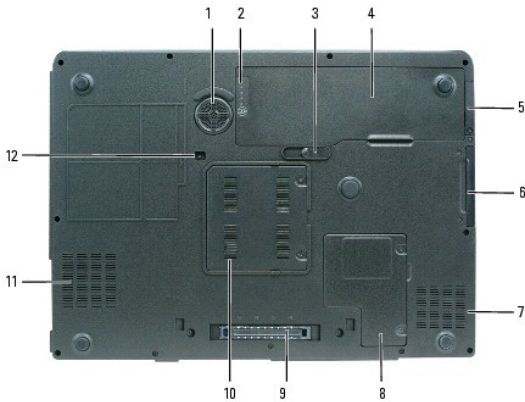

1	subwoofer	5	cover for optional internal card with Bluetooth® wireless technology	9	docking-device connector
2	battery charge/health gauge	6	hard drive	10	memory module cover
3	battery-bay latch release	7	air vent	11	air vent
4	battery	8	Mini-Card/modem cover	12	optical-drive security screw

subwoofer — Produces a broader bass output than is provided by the speakers.

battery charge/health gauge — Provides information on the battery charge status. For more information, see [Checking the Battery Charge](#).

battery-bay latch release — Releases the battery from the battery bay. For more information, see [Replacing the Battery](#).

battery — When a battery is installed, you can use the computer without connecting the computer to an electrical outlet. For more information, see [Using a Battery](#).

cover for optional internal card with Bluetooth® wireless technology — For more information, see the documentation that came with your card. To quickly enable or disable all wireless devices, press <Fn><F2>.

hard drive — Stores software and data. For more information, see [Hard Drive](#). The size displayed for your hard drive in Windows Explorer is the capacity of the drive before any operating system or programs are installed.

air vent — The computer uses fan(s) to create airflow through the vent(s), which prevents the computer from overheating.

CAUTION: Do not block, push objects into, or allow dust to accumulate in the air vents. Do not store your computer in a low-airflow environment, such as a closed briefcase, while it is running. Restricting the airflow can damage the computer or cause a fire.

Mini-Card/modem cover — Covers the compartment that contains the Mini-Card and the modem. For more information, see [Modem](#).

Docking-device connector — Lets you attach your computer to the Media Base or other docking device. See the Dell documentation that came with your docking device for more information.

NOTICE: Your computer features Undock & Go™ technology that allows you to undock your computer without going into standby mode. Because the computer may not automatically go into standby mode when it is undocked, be sure the settings in the Power Options control panel do not prohibit the computer from going into standby mode. If you change the Power Options control panel to prohibit the computer from going into standby mode, you greatly increase the chances of causing your battery to wear down quickly or causing your computer to overheat.

memory module cover — Covers the compartment that contains the memory modules. For more information, see [Memory](#).

optical-drive security screw — Secures the optical drive in the optical drive bay. For more information, see [Optical Drive](#).

[Back to Contents Page](#)

Appendix

Dell Precision™ M90 User's Guide

- [Cleaning Your Computer](#)
 - [Macrovision Product Notice](#)
 - [FCC Notice \(U.S. Only\)](#)
-

Cleaning Your Computer

 **CAUTION:** Before you begin any of the procedures in this section, follow the safety instructions located in the *Product Information Guide*.

Computer, Keyboard, and Display

 **CAUTION:** Before you clean your computer, disconnect the computer from the electrical outlet and remove any installed batteries. Clean your computer with a soft cloth dampened with water. Do not use liquid or aerosol cleaners, which may contain flammable substances.

- 1 Use a can of compressed air to remove dust from between the keys on the keyboard and to remove any dirt or lint from the display.

 **NOTICE:** To avoid damaging the computer or display, do not spray cleaning solution directly onto the display. Only use products specifically designed for cleaning displays, and follow the instructions that are included with the product.

- 1 Moisten a soft, lint-free cloth with either water or a display cleaner. Do not use alcohol or an ammonia-based cleaner. Wipe the display gently working from the center to the edges until it is clean and any fingerprints are removed. Do not use excessive pressure.
- 1 Moisten a soft, lint-free cloth with water and wipe the computer and keyboard. Do not allow water from the cloth to seep between the touch pad and the surrounding palm rest.

Touch Pad

1. Shut down and turn off your computer. See [Turning Off Your Computer](#).
2. Disconnect any attached devices from the computer and from their electrical outlets.
3. Remove any installed batteries. See [Replacing the Battery](#).
4. Moisten a soft, lint-free cloth with water, and wipe it gently across the surface of the touch pad. Do not allow water from the cloth to seep between the touch pad and the surrounding palm rest.

CDs and DVDs

 **NOTICE:** Always use compressed air to clean the lens in the CD/DVD drive, and follow the instructions that come with the compressed-air product. Never touch the lens in the drive.

If you notice problems, such as skipping, with the playback quality of your CDs or DVDs, try cleaning the discs.

1. Hold the disc by its outer edge. You can also touch the inside edge of the center hole.

 **NOTICE:** To avoid damaging the surface, do not wipe in a circular motion around the disc.

2. With a soft, lint-free cloth, gently wipe the bottom of the disc (the unlabeled side) in a straight line from the center to the outer edge of the disc.

For stubborn dirt, try using water or a diluted solution of water and mild soap. You can also purchase commercial products that clean discs and provide some protection from dust, fingerprints, and scratches. Cleaning products for CDs are also safe to use on DVDs.

Macrovision Product Notice

This product incorporates copyright protection technology that is protected by U.S. patents and other intellectual property rights. Use of this copyright protection technology must be authorized by Macrovision, and is intended for home and other limited viewing uses only unless otherwise authorized by Macrovision. Reverse engineering or disassembly is prohibited.

FCC Notice (U.S. Only)

FCC Class B

This equipment generates, uses, and can radiate radio frequency energy and, if not installed and used in accordance with the manufacturer's instruction manual, may cause interference with radio and television reception. This equipment has been tested and found to comply with the limits for a Class B digital device pursuant to Part 15 of the FCC Rules.

This device complies with Part 15 of the FCC Rules. Operation is subject to the following two conditions:

1. This device may not cause harmful interference.
2. This device must accept any interference received, including interference that may cause undesired operation.

 **NOTICE:** The FCC regulations provide that changes or modifications not expressly approved by Dell Inc. could void your authority to operate this equipment.

These limits are designed to provide reasonable protection against harmful interference in a residential installation. However, there is no guarantee that interference will not occur in a particular installation. If this equipment does cause harmful interference with radio or television reception, which can be determined by turning the equipment off and on, you are encouraged to try to correct the interference by one or more of the following measures:

- 1 Reorient the receiving antenna.
- 1 Relocate the system with respect to the receiver.
- 1 Move the system away from the receiver.
- 1 Plug the system into a different outlet so that the system and the receiver are on different branch circuits.

If necessary, consult a representative of Dell Inc. or an experienced radio/television technician for additional suggestions.

The following information is provided on the device or devices covered in this document in compliance with the FCC regulations:

- 1 **Product name:** Dell Precision™ M90
- 1 **Model number:** PP05XA
- 1 **Company name:**

Dell Inc.
Worldwide Regulatory Compliance & Environmental Affairs
One Dell Way
Round Rock, TX 78682 USA
512-338-4400

 **NOTE:** For Further regulatory information, see your *Product Information Guide*.

[Back to Contents Page](#)

[Back to Contents Page](#)

Using a Battery

Dell Precision™ M90 User's Guide

- [Battery Performance](#)
- [Checking the Battery Charge](#)
- [Conserving Battery Power](#)
- [Power Management Modes](#)
- [Configuring Power Management Settings](#)
- [Charging the Battery](#)
- [Replacing the Battery](#)
- [Storing a Battery](#)

Battery Performance

 **NOTE:** For information about the Dell warranty for your computer, see the *Product Information Guide* or separate paper warranty document that shipped with your computer.

For optimal computer performance and to help preserve BIOS settings, operate your Dell™ portable computer with the battery installed at all times. One battery is supplied as standard equipment in the battery bay.

 **NOTE:** Because the battery may not be fully charged, use the AC adapter to connect your new computer to an electrical outlet the first time you use the computer. For best results, operate the computer with the AC adapter until the battery is fully charged. To view battery charge status, click **Start**→**Control Panel**→**Power Options**, and click **Power Meter** tab.

 **NOTE:** Battery operating time (the time the battery can operate the computer) decreases over time. Depending on how often the battery is used and the conditions under which it is used, you may need to purchase a new battery during the life of your computer.

- 1 Battery operating time varies depending on operating conditions. Operating time is significantly reduced when you perform operations including, but not limited to, the following:
 - 1 Using optical drives
 - 1 Using wireless communications devices, ExpressCards, or USB devices
 - 1 Using high-brightness display settings, 3D screen savers, or other power-intensive programs such as complex 3D graphics applications
 - 1 Running the computer in maximum performance mode. See [Configuring Power Management Settings](#) for information about accessing Windows Power Options Properties or Dell QuickSet, which you can use to configure power management settings.

 **NOTE:** It is recommended that you connect your computer to an electrical outlet when writing to a CD or DVD.

You can check the battery charge before you insert the battery into the computer. You can also set power management options to alert you when the battery charge is low. For more information, see [Checking the Battery Charge](#).

 **CAUTION:** Using an incompatible battery may increase the risk of fire or explosion. Replace the battery only with a compatible battery purchased from Dell. The battery is designed to work with your Dell computer. Do not use a battery from other computers with your computer.

 **CAUTION:** Do not dispose of batteries with household waste. When your battery no longer holds a charge, call your local waste disposal or environmental agency for advice on disposing of a lithium-ion battery. See "Battery Disposal" in the *Product Information Guide*.

 **CAUTION:** Misuse of the battery may increase the risk of fire or chemical burn. Do not puncture, incinerate, disassemble, or expose the battery to temperatures above 65°C (149°F). Keep the battery away from children. Handle damaged or leaking batteries with extreme care. Damaged batteries may leak and cause personal injury or equipment damage.

Checking the Battery Charge

The Dell QuickSet **Battery Meter**, the Microsoft Windows **Power Meter** window and  icon, the battery charge gauge and health gauge, and the low-battery warning provide information on the battery charge.

 **NOTE:** Dell QuickSet may not be available on your computer.

Dell™ QuickSet Battery Meter

If Dell QuickSet is installed, press <Fn><F3> to display the QuickSet Battery Meter. The Battery Meter displays status, battery health, charge level, and charge completion time for the battery in your computer.

For more information about QuickSet, right-click the  icon in the taskbar, and click **Help**.

Microsoft® Windows® Power Meter

The Windows Power Meter indicates the remaining battery charge. To check the Power Meter, double-click the  icon on the taskbar.

If the computer is connected to an electrical outlet, a  icon appears.

Charge Gauge

By pressing (or pressing and holding) the status button on the charge gauge on the battery, you can check:



- 1 Battery charge (check by pressing and releasing the status button)
- 1 Battery health (check by pressing and holding the status button)

The battery operating time is largely determined by the number of times it is charged. After hundreds of charge and discharge cycles, batteries lose some charge capacity—or battery health. That is, a battery can show a status of "charged" but maintain a reduced charge capacity (health).

Check the Battery Charge

To check the battery charge, *press* the status button on the battery charge gauge to illuminate the charge-level lights. Each light represents approximately 20 percent of the total battery charge. For example, if the battery has 80 percent of its charge remaining, four of the lights are on. If no lights appear, the battery has no charge.

Check the Battery Health

 **NOTE:** You can check battery health either by using the charge gauge on the battery as described below, or by using the Battery Meter in Dell QuickSet. For information about QuickSet, right-click the  icon in the taskbar, and click **Help**.

To check the battery health using the charge gauge, *press and hold* the status button on the battery charge gauge for at least 3 seconds. If no lights appear, the battery is in good condition, and more than 80 percent of its original charge capacity remains. Each light represents incremental degradation. If five lights appear, less than 60 percent of the charge capacity remains, and you should consider replacing the battery. See [Specifications](#) for more information about the battery operating time.

Low-Battery Warning

 **NOTICE:** To avoid losing or corrupting data, save your work immediately after a low-battery warning. Then connect the computer to an electrical outlet. If the battery runs completely out of power, hibernate mode begins automatically.

A pop-up window warns you when the battery charge is approximately 90 percent depleted. The computer enters hibernate mode when the battery charge is at a critically low level.

You can change the settings for the battery alarms in QuickSet or the **Power Options Properties** window. See [Configuring Power Management Settings](#) for information about accessing QuickSet or the **Power Options Properties** window.

Conserving Battery Power

Perform the following actions to conserve battery power:

- 1 Connect the computer to an electrical outlet when possible because battery life is largely determined by the number of times the battery is used and recharged.
- 1 Place the computer in standby mode or hibernate mode when you leave the computer unattended for long periods of time. See [Power Management Modes](#) for more information about standby and hibernate modes.
- 1 Use the Power Management Wizard to select options to optimize your computer's power usage. These options can also be set to change when you press the power button, close the display, or press <Fn><Esc>. See [Configuring Power Management Settings](#) for more information on using the Power Management Wizard.

 **NOTE:** See [Configuring Power Management Settings](#) for information on conserving battery power.

Power Management Modes

Standby Mode

Standby mode conserves power by turning off the display and the hard drive after a predetermined period of inactivity (a time-out). When the computer exits standby mode, it returns to the same operating state it was in before entering standby mode.

 **NOTICE:** If your computer loses AC or battery power while in standby mode, it may lose data.

To enter standby mode:

- 1 Click **Start**→ **Shut Down**→ **Stand by**.

or

- 1 Depending on how you set the power management options on the **Advanced tab** in the **Power Options Properties** window, use one of the following methods:
 - o Press the power button.
 - o Close the display.
 - o Press <Fn><Esc>.

To exit standby mode, press the power button or open the display depending on how you set the options on the **Advanced tab**. You cannot make the computer exit standby mode by pressing a key or touching the touch pad.

Hibernate Mode

Hibernate mode conserves power by copying system data to a reserved area on the hard drive and then completely turning off the computer. When the computer exits hibernate mode, it returns to the same operating state it was in before entering hibernate mode.

 **NOTICE:** You should not remove devices while your computer is in hibernate mode.

Your computer enters hibernate mode if the battery charge level becomes critically low.

To manually enter hibernate mode:

- 1 Click **Start**→ **Shut Down**, press and hold <Shift>, and then click **Hibernate**.

or

- 1 Depending on how you set the power management options on the **Advanced tab** in the **Power Options Properties** window, use one of the following methods to enter hibernate mode:
 - o Press the power button.
 - o Close the display.
 - o Press <Fn><Esc>.

 **NOTE:** Some ExpressCards may not operate correctly after the computer exits hibernate mode. You may need to remove and reinsert the card (see [Removing an ExpressCard or Blank](#)), or simply restart (reboot) your computer.

To exit hibernate mode, press the power button. The computer may take a short time to exit hibernate mode. You cannot make the computer exit hibernate mode by pressing a key or touching the touch pad. For more information on hibernate mode, see the documentation that came with your operating system.

Configuring Power Management Settings

You can use the QuickSet Power Management Wizard or Windows Power Options Properties to configure the power management settings on your computer.

- 1 For more information about QuickSet, right-click the  icon in the taskbar and click **Help**.
- 1 To access the **Power Options Properties** window, click the **Start** button, point to **Control Panel**→ **Performance and Maintenance**, and then click **Power Options**. For information on any field in the **Power Options Properties** window, click the question mark icon on the title bar and then click on the area where you need information.

Charging the Battery

 **NOTE:** With Dell™ ExpressCharge™, when the computer is turned off, the AC adapter charges a completely discharged battery to 80 percent in about 1 hour and to 100 percent in approximately 2 hours. Charge time is longer with the computer turned on. You can leave the battery in the computer for as long as you like. The battery's internal circuitry prevents the battery from overcharging.

When you connect the computer to an electrical outlet or install a battery while the computer is connected to an electrical outlet, the computer checks the battery charge and temperature. If necessary, the AC adapter then charges the battery and maintains the battery charge.

If the battery is hot from being used in your computer or being in a hot environment, the battery may not charge when you connect the computer to an electrical outlet. The battery is too hot to start charging if the  light flashes alternately orange and green. Disconnect the computer from the electrical outlet and allow the computer and the battery to cool to room temperature. Then connect the computer to an electrical outlet to continue charging the battery.

For more information about resolving problems with a battery, see [Power Problems](#).

Replacing the Battery

⚠ CAUTION: Before performing these procedures, turn off the computer, disconnect the AC adapter from the electrical outlet and the computer, disconnect the modem from the wall connector and computer, and remove any other external cables from the computer.

🔇 NOTICE: You must remove all external cables from the computer to avoid possible connector damage.

⚠ CAUTION: Using an incompatible battery may increase the risk of fire or explosion. Replace the battery only with a compatible battery purchased from Dell. The battery is designed to work with your Dell™ computer. Do not use a battery from other computers with your computer.

To remove the battery:

1. If the computer is connected to a docking device (docked), undock it. See the documentation that came with your docking device for instructions.
2. Ensure that the computer is turned off.
3. Slide and hold the battery-bay latch release on the bottom of the computer, and then lift the battery from the bay.

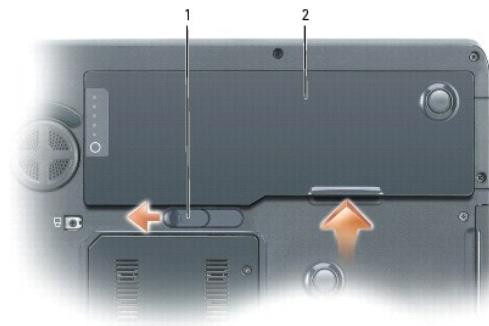

1	battery-bay latch release	2	battery		
---	---------------------------	---	---------	--	--

To replace the battery, follow the removal procedure in reverse order.

Storing a Battery

Remove the battery when you store your computer for an extended period of time. A battery discharges during prolonged storage. After a long storage period, recharge the battery fully before you use it. See [Charging the Battery](#).

[Back to Contents Page](#)

Using Cards

Dell Precision™ M90 User's Guide

- [ExpressCards](#)
- [Media Memory Cards](#)

ExpressCards

ExpressCards leverage PC Card technology to provide a fast and convenient way to add memory, wired and wireless network communications (including wireless wide area network [WWAN] communications), multimedia, and security features to your computer.

See [Specifications](#) for information on supported ExpressCards.

 **NOTE:** An ExpressCard is not a bootable device.

ExpressCard Blanks

Your computer shipped with a plastic blank installed in the ExpressCard slot. Blanks protect unused slots from dust and other particles. Save the blank for use when no ExpressCard is installed in the slot; blanks from other computers may not fit your computer.

To remove the blank, see [Removing an ExpressCard or Blank](#).

Installing an ExpressCard

You can install an ExpressCard in the computer while the computer is running. The computer automatically detects the card.

ExpressCards are generally marked with a symbol (such as a triangle or an arrow) or a label to indicate which end to insert into the slot. The cards are keyed to prevent incorrect insertion. If card orientation is not clear, see the documentation that came with the card.

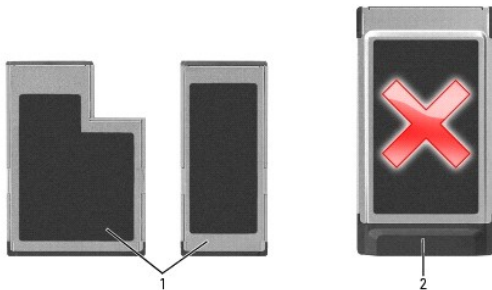

1	supported cards	2	unsupported cards		
---	-----------------	---	-------------------	--	--

 **NOTE:** Your computer does not support PC cards. To avoid damaging the pins or card, you should not attempt to insert an unsupported card into the ExpressCard slot.

 **CAUTION:** Before you begin any of the procedures in this section, follow the safety instructions in the *Product Information Guide*.

To install an ExpressCard:

1. Hold the card with the top side of the card facing up. The latch may need to be in the "in" position before you insert the card.
2. Slide the card into the slot until the card is completely seated in its connector.



If you encounter too much resistance, do not force the card. Check the card orientation and try again.



	1	ExpressCard		
--	---	-------------	--	--

The computer recognizes the ExpressCard and automatically loads the appropriate device driver. If the configuration program tells you to load the manufacturer's drivers, use the CD that came with the ExpressCard.

Removing an ExpressCard or Blank

 **NOTICE:** Use the ExpressCard configuration utility (click the  icon in the taskbar) to select a card and stop it from functioning before you remove it from the computer. If you do not stop the card in the configuration utility, you could lose data.

 **CAUTION:** Before you begin any of the procedures in this section, follow the safety instructions in the *Product Information Guide*.

Press the latch and remove the card or blank. Press the latch twice: once to pop the latch out, and then a second time to pop the card out. Save a blank to use when no ExpressCard is installed in a slot. Blanks protect unused slots from dust and other particles.



1	latch	2	ExpressCard		
---	-------	---	-------------	--	--

Media Memory Cards

The 5-in-1 media memory card reader provides a fast and convenient way to view and share digital photos, music, and videos stored on a media memory card.

 **NOTE:** A media memory card is not a bootable device.

The 5-in-1 media memory card reader reads the following media memory cards:

- 1 Secure Digital (SD) card/SDIO
- 1 MultiMediaCard (MMC)
- 1 Memory Stick
- 1 Memory Stick PRO
- 1 xD-Picture Card

Installing a Media Memory Card

You can install a media memory card in the computer while the computer is running. The computer automatically detects the card.

Media memory cards are generally marked with a symbol (such as a triangle or an arrow) or a label to indicate which end to insert into the slot. The cards are keyed to prevent incorrect insertion. If card orientation is not clear, see the documentation that came with the card.

⚠ CAUTION: Before you begin any of the procedures in this section, follow the safety instructions in the *Product Information Guide*.

To install a media memory card:

1. Hold the card with the top side of the card facing up.
2. Slide the card into the slot until the card is completely seated in its connector.

If you encounter too much resistance, do not force the card. Check the card orientation and try again.



1	5-in-1 media memory card slot	2	media memory card		
---	-------------------------------	---	-------------------	--	--

The computer recognizes the media memory card and automatically loads the appropriate device driver. If the configuration program tells you to load the manufacturer's drivers, use the CD that came with the media memory card, if applicable.

Removing a Media Memory Card

🔄 NOTICE: Use the media memory card configuration utility (click the  icon in the taskbar) to select a card and stop it from functioning before you remove it from the computer. If you do not stop the card in the configuration utility, you could lose data.

⚠ CAUTION: Before you begin any of the procedures in this section, follow the safety instructions in the *Product Information Guide*.

Press the card in to release and remove the card.

[Back to Contents Page](#)

Using the Display

Dell Precision™ M90 User's Guide

- [Adjusting Brightness](#)
 - [Switching the Video Image](#)
 - [Setting Display Resolution](#)
-

Adjusting Brightness

When a Dell™ computer is running on battery power, you can conserve power by setting the brightness to the lowest comfortable setting by pressing <Fn> and the up- or down-arrow key on the keyboard.

 **NOTE:** Brightness key combinations only affect the display on your portable computer, not monitors or projectors that you attach to your portable computer or docking device. If your computer is connected to an external monitor and you try to change the brightness level, the Brightness Meter appears, but the brightness level on the monitor does not change.

You can press the following keys to adjust display brightness:

- 1 Press <Fn> and the up-arrow key to increase brightness on the integrated display only (not on an external monitor).
 - 1 Press <Fn> and the down-arrow key to decrease brightness on the integrated display only (not on an external monitor).
-

Switching the Video Image

When you start the computer with an external device (such as an external monitor or projector) attached and turned on, the image may appear on either the computer display or the external device.

Press <Fn><F8> to switch the video image between the display only, the external device only, or the display and the external device simultaneously.

Setting Display Resolution

To display a program at a specific resolution, both the graphics card and the display must support the program, and the necessary video drivers must be installed.

 **NOTE:** If you change the display resolution from the current settings, the image may appear blurry or text may be harder to read. Before you change any of the display settings, make a note of the current settings for future use.



If you choose a resolution or color palette that is higher than the display supports, the settings adjust automatically to the closest supported values.



1. Click the **Start** button and click **Control Panel**.
2. Under **Pick a category**, click **Appearance and Themes**.
3. Under **Pick a task...**, click the area you want to change, or under **or pick a Control Panel icon**, click **Display**.
4. Try different settings for **Color quality** and **Screen resolution**.



 **NOTE:** As the resolution increases, icons and text appear smaller on the screen.

Finding Information

Dell Precision™ M90 User's Guide

-  **NOTE:** Some features or media may be optional and may not ship with your computer. Some features or media may not be available in certain countries.
-  **NOTE:** Additional information may ship with your computer.

What Are You Looking For?	Find It Here
<ul style="list-style-type: none"> 1 A diagnostic program for my computer 1 Drivers for my computer 1 My device documentation 1 Notebook System Software (NSS) 	<p>Drivers and Utilities CD (also known as ResourceCD)</p> <p>NOTE: The <i>Drivers and Utilities</i> CD may be optional and may not ship with your computer.</p> <p>Documentation and drivers are already installed on your computer. You can use the CD to reinstall drivers (see Reinstalling Drivers and Utilities) or to run the Dell Diagnostics (see Dell Diagnostics).</p>  <p>Readme files may be included on your CD to provide last-minute updates about technical changes to your computer or advanced technical-reference material for technicians or experienced users.</p> <p>NOTE: Drivers and documentation updates can be found at support.dell.com.</p>
<ul style="list-style-type: none"> 1 How to set up my computer 1 Basic troubleshooting information 1 How to run the Dell Diagnostics 1 How to remove and install parts 	<p>Quick Reference Guide</p> <p>NOTE: This document may be optional and may not ship with your computer.</p>  <p>NOTE: This document is available as a PDF at support.dell.com.</p>
<ul style="list-style-type: none"> 1 Warranty information 1 Terms and Conditions (U.S. only) 1 Safety instructions 1 Regulatory information 1 Ergonomics information 1 End User License Agreement 	<p>Dell™ Product Information Guide</p> 
<ul style="list-style-type: none"> 1 How to remove and replace parts 1 Specifications 1 How to configure system settings 1 How to troubleshoot and solve problems 	<p>Dell Precision™ User's Guide</p> <p><i>Microsoft Windows XP Help and Support Center</i></p> <ol style="list-style-type: none"> 1. Click Start→ Help and Support→ Dell User and System Guides→ System Guides.

	<ol style="list-style-type: none"> 2. Click the <i>User's Guide</i> for your computer.
<ol style="list-style-type: none"> 1 Service Tag and Express Service Code 1 Microsoft Windows License Label 	<p>Service Tag and Microsoft® Windows® License</p> <p>These labels are located on the bottom of your computer.</p> <ol style="list-style-type: none"> 1 Use the Service Tag to identify your computer when you use support.dell.com or contact technical support.  <ol style="list-style-type: none"> 1 Enter the Express Service Code to direct your call when contacting technical support.
<ol style="list-style-type: none"> 1 Solutions — Troubleshooting hints and tips, articles from technicians, and online courses, frequently asked questions 1 Community — Online discussion with other Dell customers 1 Upgrades — Upgrade information for components, such as memory, the hard drive, and the operating system 1 Customer Care — Contact information, service call and order status, warranty, and repair information 1 Service and support — Service call status and support history, service contract, online discussions with technical support 1 Reference — Computer documentation, details on my computer configuration, product specifications, and white papers 1 Downloads — Certified drivers, patches, and software updates 1 Notebook System Software (NSS)— If you reinstall the operating system for your computer, you should also reinstall the NSS utility. NSS provides critical updates for your operating system and support for Dell™ 3.5-inch USB floppy drives, Intel® processors, optical drives, and USB devices. NSS is necessary for correct operation of your Dell computer. The software automatically detects your computer and operating system and installs the updates appropriate for your configuration. 	<p>Dell Support Website — support.dell.com</p> <p>NOTE: Select your region to view the appropriate support site.</p> <p>To download Notebook System Software:</p> <ol style="list-style-type: none"> 1. Go to support.dell.com, select your region or business segment, and enter your Service Tag. 2. Select Drivers & Downloads and click Go. 3. Click your operating system and search for the keyword <i>Notebook System Software</i>. <p>NOTE: The support.dell.com user interface may vary depending on your selections.</p>
<ol style="list-style-type: none"> 1 Software upgrades and troubleshooting hints — Frequently asked questions, hot topics, and general health of your computing environment 	<p>Dell Support Utility</p> <p>The Dell Support Utility is an automated upgrade and notification system installed on your computer. This support provides real-time health scans of your computing environment, software updates, and relevant self-support information. Access the Dell Support Utility from the  icon in the taskbar. For more information, see Dell Support Utility.</p>
<ol style="list-style-type: none"> 1 How to use Windows XP 1 How to work with programs and files 1 How to personalize my desktop 	<p>Windows Help and Support Center</p> <ol style="list-style-type: none"> 1. Click the Start button and click Help and Support. 2. Type a word or phrase that describes your problem and click the arrow icon. 3. Click the topic that describes your problem. 4. Follow the instructions on the screen.
<ol style="list-style-type: none"> 1 Information on network activity, the Power Management Wizard, hotkeys, and other items controlled by Dell QuickSet 	<p>Dell QuickSet Help</p> <p>To view <i>Dell QuickSet Help</i>, right-click the  icon in the Microsoft® Windows® taskbar.</p> <p>For more information on Dell QuickSet, see Dell™ QuickSet.</p>
<ol style="list-style-type: none"> 1 How to reinstall my operating system 	<p>Operating System CD</p>

NOTE: The *Operating System* CD may be optional and may not ship with your computer.

The operating system is already installed on your computer. To reinstall your operating system, use the optional *Operating System* CD. See [Reinstalling Windows XP](#).

After you reinstall your operating system, use the *Drivers and Utilities* CD (*ResourceCD*) to reinstall drivers for the devices that came with your computer.



NOTE: The color of your CD varies based on the operating system you ordered.

[Back to Contents Page](#)

Glossary

Dell Precision™ M90 User's Guide

A	I	S
B	K	T
C	L	U
D	M	V
E	N	W
F	O	X
G	P	Z
H	R	

Terms in this Glossary are provided for informational purposes only and may or may not describe features included with your particular computer.

A

AC — alternating current — The form of electricity that powers your computer when you plug the AC adapter power cable in to an electrical outlet.

ACPI — advanced configuration and power interface — A power management specification that enables Microsoft® Windows® operating systems to put a computer in standby or hibernate mode to conserve the amount of electrical power allocated to each device attached to the computer.

AGP — accelerated graphics port — A dedicated graphics port that allows system memory to be used for video-related tasks. AGP delivers a smooth, true-color video image because of the faster interface between the video circuitry and the computer memory.

ALS — ambient light sensor.

antivirus software — A program designed to identify, quarantine, and/or delete viruses from your computer.

APR — advanced port replicator — A docking device that allows you to conveniently use an external monitor, keyboard, mouse, and other devices with your portable computer.

ASF — alert standards format — A standard to define a mechanism for reporting hardware and software alerts to a management console. ASF is designed to be platform- and operating system-independent.

B

backup — A copy of a program or data file on a floppy, CD, DVD, or hard drive. As a precaution, back up the data files from your hard drive regularly.

battery — A rechargeable internal power source used to operate portable computers when not connected to an AC adapter and an electrical outlet.

battery life span — The length of time (years) during which a portable computer battery is able to be depleted and recharged.

battery operating time — The length of time (minutes or hours) that a portable computer battery holds a charge while powering the computer.

BIOS — basic input/output system — A program (or utility) that serves as an interface between the computer hardware and the operating system. Unless you understand what effect these settings have on the computer, do not change them. Also referred to as *system setup*.

bit — The smallest unit of data interpreted by your computer.

Bluetooth® wireless technology — A wireless technology standard for short-range (9 m [29 feet]) networking devices that allows for enabled devices to automatically recognize each other.

boot sequence — Specifies the order of the devices from which the computer attempts to boot.

bootable CD — A CD that you can use to start your computer. In case your hard drive is damaged or your computer has a virus, ensure that you always have a bootable CD or floppy disk available. Your *Drivers and Utilities* or Resource CD is a bootable CD.

bootable disk — A disk that you can use to start your computer. In case your hard drive is damaged or your computer has a virus, ensure that you always have a bootable CD or floppy disk available.

bps — bits per second — The standard unit for measuring data transmission speed.

BTU — British thermal unit — A measurement of heat output.

bus — A communication pathway between the components in your computer.

bus speed — The speed, given in MHz, that indicates how fast a bus can transfer information.

byte — The basic data unit used by your computer. A byte is usually equal to 8 bits.

C

C — Celsius — A temperature measurement scale where 0° is the freezing point and 100° is the boiling point of water.

cache — A special high-speed storage mechanism which can be either a reserved section of main memory or an independent high-speed storage device. The cache enhances the efficiency of many processor operations.

L1 cache — Primary cache stored inside the processor.

L2 cache — Secondary cache which can either be external to the processor or incorporated into the processor architecture.

carnet — An international customs document that facilitates temporary imports into foreign countries. Also known as a *merchandise passport*.

CD — compact disc — An optical form of storage media, typically used for audio and software programs.

CD drive — A drive that uses optical technology to read data from CDs.

CD player — The software used to play music CDs. The CD player displays a window with buttons that you use to play a CD.

CD-R — CD recordable — A recordable version of a CD. Data can be recorded only once onto a CD-R. Once recorded, the data cannot be erased or written over.

CD-RW — CD rewritable — A rewritable version of a CD. Data can be written to a CD-RW disc, and then erased and written over (rewritten).

CD-RW drive — A drive that can read CDs and write to CD-RW (rewritable CDs) and CD-R (recordable CDs) discs. You can write to CD-RW discs multiple times, but you can write to CD-R discs only once.

CD-RW/DVD drive — A drive, sometimes referred to as a combo drive, that can read CDs and DVDs and write to CD-RW (rewritable CDs) and CD-R (recordable CDs) discs. You can write to CD-RW discs multiple times, but you can write to CD-R discs only once.

clock speed — The speed, given in MHz, that indicates how fast computer components that are connected to the system bus operate.

COA — Certificate of Authenticity — The Windows alpha-numeric code located on a sticker on your computer. Also referred to as the *Product Key* or *Product ID*.

Control Panel — A Windows utility that allows you to modify operating system and hardware settings, such as display settings.

controller — A chip that controls the transfer of data between the processor and memory or between the processor and devices.

CRIMM — continuity rambus in-line memory module — A special module that has no memory chips and is used to fill unused RIMM slots.

cursor — The marker on a display or screen that shows where the next keyboard, touch pad, or mouse action will occur. It often is a blinking solid line, an underline character, or a small arrow.

D

DDR SDRAM — double-data-rate SDRAM — A type of SDRAM that doubles the data burst cycle, improving system performance.

DDR2 SDRAM — double-data-rate 2 SDRAM — A type of DDR SDRAM that uses a 4-bit prefetch and other architectural changes to boost memory speed to over 400 MHz.

device — Hardware such as a disk drive, printer, or keyboard that is installed in or connected to your computer.

device driver — See *driver*.

DIN connector — A round, six-pin connector that conforms to DIN (Deutsche Industrie-Norm) standards; it is typically used to connect PS/2 keyboard or mouse cable connectors.

disk striping — A technique for spreading data over multiple disk drives. Disk striping can speed up operations that retrieve data from disk storage. Computers that use disk striping generally allow the user to select the data unit size or stripe width.

DMA — direct memory access — A channel that allows certain types of data transfer between RAM and a device to bypass the processor.

docking device — See *APR*.

DMTF — Distributed Management Task Force — A consortium of hardware and software companies who develop management standards for distributed desktop, network, enterprise, and Internet environments.

domain — A group of computers, programs, and devices on a network that are administered as a unit with common rules and procedures for use by a specific group of users. A user logs on to the domain to gain access to the resources.

DRAM — dynamic random-access memory — Memory that stores information in integrated circuits containing capacitors.

driver — Software that allows the operating system to control a device such as a printer. Many devices do not work properly if the correct driver is not installed in the computer.

DSL — Digital Subscriber Line — A technology that provides a constant, high-speed Internet connection through an analog telephone line.

dual display mode — A display setting that allows you to use a second monitor as an extension of your display. Also referred to as *extended display mode*.

DVD — digital versatile disc — A high-capacity disc usually used to store movies. DVD drives read most CD media as well.

DVD drive — A drive that uses optical technology to read data from DVDs and CDs.

DVD player — The software used to watch DVD movies. The DVD player displays a window with buttons that you use to watch a movie.

DVD-R — DVD recordable — A recordable version of a DVD. Data can be recorded only once onto a DVD-R. Once recorded, the data cannot be erased or written over.

DVD+RW — DVD rewritable — A rewritable version of a DVD. Data can be written to a DVD+RW disc, and then erased and written over (rewritten). (DVD+RW technology is different from DVD-RW technology.)

DVD+RW drive — drive that can read DVDs and most CD media and write to DVD+RW (rewritable DVDs) discs.

DVI — digital video interface — A standard for digital transmission between a computer and a digital video display.

E

ECC — error checking and correction — A type of memory that includes special circuitry for testing the accuracy of data as it passes in and out of memory.

ECP — extended capabilities port — A parallel connector design that provides improved bidirectional data transmission. Similar to EPP, ECP uses direct memory access to transfer data and often improves performance.

EIDE — enhanced integrated device electronics — An improved version of the IDE interface for hard drives and CD drives.

EMI — electromagnetic interference — Electrical interference caused by electromagnetic radiation.

ENERGY STAR® — Environmental Protection Agency requirements that decrease the overall consumption of electricity.

EPP — enhanced parallel port — A parallel connector design that provides bidirectional data transmission.

ESD — electrostatic discharge — A rapid discharge of static electricity. ESD can damage integrated circuits found in computer and communications equipment.

expansion card — A circuit board that installs in an expansion slot on the system board in some computers, expanding the capabilities of the computer. Examples include video, modem, and sound cards.

expansion slot — A connector on the system board (in some computers) where you insert an expansion card, connecting it to the system bus.

ExpressCard — A removable I/O card adhering to the PCMCIA standard. Modems and network adapters are common types of ExpressCards. ExpressCards support both the PCI Express and USB 2.0 standard.

Express Service Code — A numeric code located on a sticker on your Dell™ computer. Use the Express Service Code when contacting Dell for assistance. Express Service Code service may not be available in some countries.

extended display mode — A display setting that allows you to use a second monitor as an extension of your display. Also referred to as *dual display mode*.

extended PC Card — A PC Card that extends beyond the edge of the PC Card slot when installed.

F

Fahrenheit — A temperature measurement scale where 32° is the freezing point and 212° is the boiling point of water.

FCC — Federal Communications Commission — A U.S. agency responsible for enforcing communications-related regulations that state how much radiation computers and other electronic equipment can emit.

floppy — An electromagnetic form of storage media. Also known as a floppy diskette or a floppy disk.

floppy drive — A disk drive that can read and write to floppy disks.

folder — A term used to describe space on a disk or drive where files are organized and grouped. Files in a folder can be viewed and ordered in various ways, such as alphabetically, by date, and by size.

format — The process that prepares a drive or disk for file storage. When a drive or disk is formatted, the existing information on it is lost.

FSB — front side bus — The data path and physical interface between the processor and RAM.

FTP — file transfer protocol — A standard Internet protocol used to exchange files between computers connected to the Internet.

G

G — gravity — A measurement of weight and force.

GB — gigabyte — A measurement of data storage that equals 1024 MB (1,073,741,824 bytes). When used to refer to hard drive storage, the term is often rounded to 1,000,000,000 bytes.

GHz — gigahertz — A measurement of frequency that equals one thousand million Hz, or one thousand MHz. The speeds for computer processors, buses, and interfaces are often measured in GHz.

graphics mode — A video mode that can be defined as x horizontal pixels by y vertical pixels by z colors. Graphics modes can display an unlimited variety of shapes and fonts.

GUI — graphical user interface — Software that interacts with the user by means of menus, windows, and icons. Most programs that operate on the Windows

operating systems are GUIs.

H

hard drive — A drive that reads and writes data on a hard disk. The terms hard drive and hard disk are often used interchangeably.

heat sink — A metal plate on some processors that helps dissipate heat.

help file — A file that contains descriptive or instructional information about a product. Some help files are associated with a particular program, such as *Help* in Microsoft Word. Other help files function as stand-alone reference sources. Help files typically have a filename extension of **.hlp** or **.chm**.

hibernate mode — A power management mode that saves everything in memory to a reserved space on the hard drive and then turns off the computer. When you restart the computer, the memory information that was saved to the hard drive is automatically restored.

HTML — hypertext markup language — A set of codes inserted into an Internet web page intended for display on an Internet browser.

HTTP — hypertext transfer protocol — A protocol for exchanging files between computers connected to the Internet.

Hz — hertz — A unit of frequency measurement that equals 1 cycle per second. Computers and electronic devices are often measured in kilohertz (kHz), megahertz (MHz), gigahertz (GHz), or terahertz (THz).

I

IC — integrated circuit — A semiconductor wafer, or chip, on which thousands or millions of tiny electronic components are fabricated for use in computer, audio, and video equipment.

IDE — integrated device electronics — An interface for mass storage devices in which the controller is integrated into the hard drive or CD drive.

IEEE 1394 — Institute of Electrical and Electronics Engineers, Inc. — A high-performance serial bus used to connect IEEE 1394-compatible devices, such as digital cameras and DVD players, to the computer.

infrared sensor — A port that allows you to transfer data between the computer and infrared-compatible devices without using a cable connection.

integrated — Usually refers to components that are physically located on the computer's system board. Also referred to as *built-in*.

I/O — input/output — An operation or device that enters and extracts data from your computer. Keyboards and printers are I/O devices.

I/O address — An address in RAM that is associated with a specific device (such as a serial connector, parallel connector, or expansion slot) and allows the processor to communicate with that device.

IrDA — Infrared Data Association — The organization that creates international standards for infrared communications.

IRQ — interrupt request — An electronic pathway assigned to a specific device so that the device can communicate with the processor. Each device connection must be assigned an IRQ. Although two devices can share the same IRQ assignment, you cannot operate both devices simultaneously.

ISP — Internet service provider — A company that allows you to access its host server to connect directly to the Internet, send and receive e-mail, and access websites. The ISP typically provides you with a software package, user name, and access phone numbers for a fee.

K

Kb — kilobit — A unit of data that equals 1024 bits. A measurement of the capacity of memory integrated circuits.

KB — kilobyte — A unit of data that equals 1024 bytes but is often referred to as 1000 bytes.

key combination — A command requiring you to press multiple keys at the same time.

kHz — kilohertz — A measurement of frequency that equals 1000 Hz.

L

LAN — local area network — A computer network covering a small area. A LAN usually is confined to a building or a few nearby buildings. A LAN can be connected to another LAN over any distance through telephone lines and radio waves to form a wide area network (WAN).

LCD — liquid crystal display — The technology used by portable computer and flat-panel displays.

LED — light-emitting diode — An electronic component that emits light to indicate the status of the computer.

local bus — A data bus that provides a fast throughput for devices to the processor.

LPT — line print terminal — The designation for a parallel connection to a printer or other parallel device.

M

Mb — megabit — A measurement of memory chip capacity that equals 1024 Kb.

Mbps — megabits per second — One million bits per second. This measurement is typically used for transmission speeds for networks and modems.

MB — megabyte — A measurement of data storage that equals 1,048,576 bytes. 1 MB equals 1024 KB. When used to refer to hard drive storage, the term is often rounded to 1,000,000 bytes.

MB/sec — megabytes per second — One million bytes per second. This measurement is typically used for data transfer ratings.

memory — A temporary data storage area inside your computer. Because the data in memory is not permanent, it is recommended that you frequently save your files while you are working on them, and always save your files before you shut down the computer. Your computer can contain several different forms of memory, such as RAM, ROM, and video memory. Frequently, the word memory is used as a synonym for RAM.

memory address — A specific location where data is temporarily stored in RAM.

memory mapping — The process by which the computer assigns memory addresses to physical locations at start-up. Devices and software can then identify information that the processor can access.

memory module — A small circuit board containing memory chips, which connects to the system board.

MHz — megahertz — A measure of frequency that equals 1 million cycles per second. The speeds for computer processors, buses, and interfaces are often measured in MHz.

Mobile Broadband network — A wireless high-speed data network using cellular technology and covering a much larger geographic area than WLAN. Also known as *WWAN*.

modem — A device that allows your computer to communicate with other computers over analog telephone lines. Three types of modems include: external, PC Card, and internal. You typically use your modem to connect to the Internet and exchange e-mail.

module bay — A bay that supports devices such as optical drives, a second battery, or a Dell TravelLite™ module.

monitor — The high-resolution TV-like device that displays computer output.

mouse — A pointing device that controls the movement of the cursor on your screen. Typically you roll the mouse over a hard, flat surface to move the pointer or cursor on your screen.

ms — millisecond — A measure of time that equals one thousandth of a second. Access times of storage devices are often measured in ms.

N

network adapter — A chip that provides network capabilities. A computer may include a network adapter on its system board, or it may contain a PC Card with an adapter on it. A network adapter is also referred to as a *NIC* (network interface controller).

NIC — See *network adapter*.

notification area — The section of the Windows taskbar that contains icons for providing quick access to programs and computer functions, such as the clock, volume control, and print status. Also referred to as *system tray*.

ns — nanosecond — A measure of time that equals one billionth of a second.

NVRAM — nonvolatile random access memory — A type of memory that stores data when the computer is turned off or loses its external power source. NVRAM is used for maintaining computer configuration information such as date, time, and other system setup options that you can set.

O

optical drive — A drive that uses optical technology to read or write data from CDs, DVDs, or DVD+RWs. Example of optical drives include CD drives, DVD drives, CD-RW drives, and CD-RW/DVD combo drives.

P

parallel connector — An I/O port often used to connect a parallel printer to your computer. Also referred to as an *LPT port*.

partition — A physical storage area on a hard drive that is assigned to one or more logical storage areas known as logical drives. Each partition can contain multiple logical drives.

PC Card — A removable I/O card adhering to the PCMCIA standard. Modems and network adapters are common types of PC Cards.

PCI — peripheral component interconnect — PCI is a local bus that supports 32-and 64-bit data paths, providing a high-speed data path between the processor and devices such as video, drives, and networks.

PCI Express — A modification to the PCI interface that boosts the data transfer rate between the processor and the devices attached to it. PCI Express can transfer data at speeds from 250 MB/sec to 4 GB/sec. If the PCI Express chip set and the device are capable of different speeds, they will operate at the slower speed.

PCMCIA — Personal Computer Memory Card International Association — The organization that establishes standards for PC Cards.

PIN — personal identification number — A sequence of numerals and/or letters used to restrict unauthorized access to computer networks and other secure systems.

PIO — programmed input/output — A method of transferring data between two devices through the processor as part of the data path.

pixel — A single point on a display screen. Pixels are arranged in rows and columns to create an image. A video resolution, such as 800 x 600, is expressed as the number of pixels across by the number of pixels up and down.

Plug-and-Play — The ability of the computer to automatically configure devices. Plug and Play provides automatic installation, configuration, and compatibility with existing hardware if the BIOS, operating system, and all devices are Plug and Play compliant.

POST — power-on self-test — Diagnostics programs, loaded automatically by the BIOS, that perform basic tests on the major computer components, such as memory, hard drives, and video. If no problems are detected during POST, the computer continues the start-up.

processor — A computer chip that interprets and executes program instructions. Sometimes the processor is referred to as the CPU (central processing unit).

program — Any software that processes data for you, including spreadsheet, word processor, database, and game packages. Programs require an operating system to run.

PS/2 — personal system/2 — A type of connector for attaching a PS/2-compatible keyboard, mouse, or keypad.

PXE — pre-boot execution environment — A WfM (Wired for Management) standard that allows networked computers that do not have an operating system to be configured and started remotely.

R

RAID — redundant array of independent disks — A method of providing data redundancy. Some common implementations of RAID include RAID 0, RAID 1, RAID 5, RAID 10, and RAID 50.

RAM — random-access memory — The primary temporary storage area for program instructions and data. Any information stored in RAM is lost when you shut down your computer.

readme file — A text file included with a software package or hardware product. Typically, readme files provide installation information and describe new product enhancements or corrections that have not yet been documented.

read-only — Data and/or files you can view but cannot edit or delete. A file can have read-only status if:

- o It resides on a physically write-protected floppy disk, CD, or DVD.
- o It is located on a network in a directory and the system administrator has assigned rights only to specific individuals.

refresh rate — The frequency, measured in Hz, at which your screen's horizontal lines are recharged (sometimes also referred to as its *vertical frequency*). The higher the refresh rate, the less video flicker can be seen by the human eye.

resolution — The sharpness and clarity of an image produced by a printer or displayed on a monitor. The higher the resolution, the sharper the image.

RFI — radio frequency interference — Interference that is generated at typical radio frequencies, in the range of 10 kHz to 100,000 MHz. Radio frequencies are at the lower end of the electromagnetic frequency spectrum and are more likely to have interference than the higher frequency radiations, such as infrared and light.

ROM — read-only memory — Memory that stores data and programs that cannot be deleted or written to by the computer. ROM, unlike RAM, retains its contents after you shut down your computer. Some programs essential to the operation of your computer reside in ROM.

RPM — revolutions per minute — The number of rotations that occur per minute. Hard drive speed is often measured in rpm.

RTC — real time clock — Battery-powered clock on the system board that keeps the date and time after you shut down the computer.

RTCST — real-time clock reset — A jumper on the system board of some computers that can often be used for troubleshooting problems.

S

ScanDisk — A Microsoft utility that checks files, folders, and the hard disk's surface for errors. ScanDisk often runs when you restart the computer after it has stopped responding.

SDRAM — synchronous dynamic random-access memory — A type of DRAM that is synchronized with the optimal clock speed of the processor.

serial connector — An I/O port often used to connect devices such as a handheld digital device or digital camera to your computer.

Service Tag — A bar code label on your computer that identifies your computer when you access Dell Support at support.dell.com or when you call Dell for customer service or technical support.

setup program — A program that is used to install and configure hardware and software. The **setup.exe** or **install.exe** program comes with most Windows software packages. *Setup program* differs from *system setup*.

shortcut — An icon that provides quick access to frequently used programs, files, folders, and drives. When you place a shortcut on your Windows desktop and double-click the icon, you can open its corresponding folder or file without having to find it first. Shortcut icons do not change the location of files. If you delete a shortcut, the original file is not affected. Also, you can rename a shortcut icon.

shutdown — The process of closing windows and exiting programs, exiting the operating system, and turning off your computer. You can lose data if you turn off your computer before completing a shutdown.

smart card — A card that is embedded with a processor and a memory chip. Smart cards can be used to authenticate a user on computers equipped for smart cards.

software — Anything that can be stored electronically, such as computer files or programs.

S/PDIF — Sony/Philips Digital Interface — An audio transfer file format that allows the transfer of audio from one file to another without converting it to and from an analog format, which could degrade the quality of the file.

standby mode — A power management mode that shuts down all unnecessary computer operations to save energy.

Strike Zone™ — Reinforced area of the platform base that protects the hard drive by acting as a dampening device when a computer experiences resonating shock or is dropped (whether the computer is on or off).

surge protectors — Prevent voltage spikes, such as those that may occur during an electrical storm, from entering the computer through the electrical outlet. Surge protectors do not protect against lightning strikes or against brownouts, which occur when the voltage drops more than 20 percent below the normal AC-line voltage level.

Network connections cannot be protected by surge protectors. Always disconnect the network cable from the network connector during electrical storms.

SIM — Subscriber Identity Module. A SIM card contains a microchip that encrypts voice and data transmissions. SIM cards can be used in phones or portable computers.

SVGA — super-video graphics array — A video standard for video cards and controllers. Typical SVGA resolutions are 800 x 600 and 1024 x 768.

The number of colors and resolution that a program displays depends on the capabilities of the monitor, the video controller and its drivers, and the amount of video memory installed in the computer.

S-video TV-out — A connector used to attach a TV or digital audio device to the computer.

SXGA — super-extended graphics array — A video standard for video cards and controllers that supports resolutions up to 1280 x 1024.

SXGA+ — super-extended graphics array plus — A video standard for video cards and controllers that supports resolutions up to 1400 x 1050.

system board — The main circuit board in your computer. Also known as the *motherboard*.

system setup — A utility that serves as an interface between the computer hardware and the operating system. System setup allows you to configure user-selectable options in the BIOS, such as date and time or system password. Unless you understand what effect the settings have on the computer, do not change the settings for this program.

system tray — See *notification area*.

T

TAPI — telephony application programming interface — Enables Windows programs to operate with a wide variety of telephony devices, including voice, data, fax, and video.

text editor — A program used to create and edit files that contain only text; for example, Windows Notepad uses a text editor. Text editors do not usually provide word wrap or formatting functionality (the option to underline, change fonts, and so on).

travel module — A plastic device designed to fit inside the module bay of a portable computer to reduce the weight of the computer.

U

UMA — unified memory allocation — System memory dynamically allocated to video.

UPS — uninterruptible power supply — A backup power source used when the electrical power fails or drops to an unacceptable voltage level. A UPS keeps a computer running for a limited amount of time when there is no electrical power. UPS systems typically provide surge suppression and may also provide voltage regulation. Small UPS systems provide battery power for a few minutes to enable you to shut down your computer.

USB — universal serial bus — A hardware interface for a low-speed device such as a USB-compatible keyboard, mouse, joystick, scanner, set of speakers, printer, broadband devices (DSL and cable modems), imaging devices, or storage devices. Devices are plugged directly in to a 4-pin socket on your computer or in to a multi-port hub that plugs in to your computer. USB devices can be connected and disconnected while the computer is turned on, and they can also be daisy-chained together.

UTP — unshielded twisted pair — Describes a type of cable used in most telephone networks and some computer networks. Pairs of unshielded wires are twisted to protect against electromagnetic interference, rather than relying on a metal sheath around each pair of wires to protect against interference.

UXGA — ultra extended graphics array — A video standard for video cards and controllers that supports resolutions up to 1600 x 1200.

V

video controller — The circuitry on a video card or on the system board (in computers with an integrated video controller) that provides the video capabilities—in combination with the monitor—for your computer.

video memory — Memory that consists of memory chips dedicated to video functions. Video memory is usually faster than system memory. The amount of video memory installed primarily influences the number of colors that a program can display.

video mode — A mode that describes how text and graphics are displayed on a monitor. Graphics-based software, such as Windows operating systems, displays in video modes that can be defined as x horizontal pixels by y vertical pixels by z colors. Character-based software, such as text editors, displays in video modes that can be defined as x columns by y rows of characters.

video resolution — See *resolution*.

virus — A program that is designed to inconvenience you or to destroy data stored on your computer. A virus program moves from one computer to another through an infected disk, software downloaded from the Internet, or e-mail attachments. When an infected program starts, its embedded virus also starts.

A common type of virus is a boot virus, which is stored in the boot sectors of a floppy disk. If the floppy disk is left in the drive when the computer is shut down and then turned on, the computer is infected when it reads the boot sectors of the floppy disk expecting to find the operating system. If the computer is infected, the boot virus may replicate itself onto all the floppy disks that are read or written in that computer until the virus is eradicated.

V — volt — The measurement of electric potential or electromotive force. One V appears across a resistance of 1 ohm when a current of 1 ampere flows through that resistance.

W

W — watt — The measurement of electrical power. One W is 1 ampere of current flowing at 1 volt.

WHr — watt-hour — A unit of measure commonly used to indicate the approximate capacity of a battery. For example, a 66-WHr battery can supply 66 W of power for 1 hour or 33 W for 2 hours.

wallpaper — The background pattern or picture on the Windows desktop. Change your wallpaper through the Windows Control Panel. You can also scan in your favorite picture and make it wallpaper.

WLAN — wireless local area network. A series of interconnected computers that communicate with each other over the air waves using access points or wireless routers to provide Internet access.

write-protected — Files or media that cannot be changed. Use write-protection when you want to protect data from being changed or destroyed. To write-protect a 3.5-inch floppy disk, slide its write-protect tab to the open position.

WWAN — wireless wide area network. See *Mobile Broadband network*. A wireless high-speed data network using cellular technology and covering a much larger geographic area than WLAN.

WXGA — wide-aspect extended graphics array — A video standard for video cards and controllers that supports resolutions up to 1280 x 800."

X

XGA — extended graphics array — A video standard for video cards and controllers that supports resolutions up to 1024 x 768.

Z

ZIF — zero insertion force — A type of socket or connector that allows a computer chip to be installed or removed with no stress applied to either the chip or its socket.

Zip — A popular data compression format. Files that have been compressed with the Zip format are called Zip files and usually have a filename extension of **.zip**. A special kind of zipped file is a self-extracting file, which has a filename extension of **.exe**. You can unzip a self-extracting file by double-clicking it.

Zip drive — A high-capacity floppy drive developed by Iomega Corporation that uses 3.5-inch removable disks called Zip disks. Zip disks are slightly larger than regular floppy disks, about twice as thick, and hold up to 100 MB of data.

[Back to Contents Page](#)

[Back to Contents Page](#)

Getting Help

Dell Precision™ M90 User's Guide

- [Obtaining Assistance](#)
 - [Problems With Your Order](#)
 - [Product Information](#)
 - [Returning Items for Warranty Repair or Credit](#)
 - [Before You Call](#)
 - [Contacting Dell](#)
-

Obtaining Assistance

 **CAUTION:** If you need to remove the computer covers, first disconnect the computer power and modem cables from all electrical outlets.

1. Complete the procedures in "Troubleshooting". See [Troubleshooting](#).
2. Run the Dell Diagnostics. See [Dell Diagnostics](#).
3. Make a copy of the [Diagnostics Checklist](#) and fill it out. See [Diagnostics Checklist](#).
4. Use Dell's extensive suite of online services available at Dell Support (support.dell.com) for help with installation and troubleshooting procedures.
5. If the preceding steps have not resolved the problem, contact Dell See [Contacting Dell](#).

NOTE: Call support from a telephone near or at the computer so that a support representative can assist you with any necessary procedures.

NOTE: Dell's Express Service Code system may not be available in all countries.

When prompted by Dell's automated telephone system, enter your Express Service Code to route the call directly to the proper support personnel. If you do not have an Express Service Code, open the **Dell Accessories** folder, double-click the **Express Service Code** icon, and follow the directions.

For instructions on using the support service, see [Support Service](#).

NOTE: Some of the following services are not always available in all locations outside the continental U.S. Call your local Dell representative for information on availability.

Online Services

You can access Dell Support at support.dell.com. Select your region on the **WELCOME TO DELL SUPPORT** page, and fill in the requested details to access help tools and information.

You can contact Dell electronically using the following addresses:

- 1 World Wide Web

www.dell.com/

www.dell.com/ap/ (Asian/Pacific countries only)

www.dell.com/jp (Japan only)

www.euro.dell.com (Europe only)

www.dell.com/la/ (Latin American countries)

www.dell.ca (Canada only)

- 1 Anonymous file transfer protocol (FTP)

[ftp.dell.com/](ftp://ftp.dell.com/)

Log in as user: `anonymous`, and use your e-mail address as your password.

- 1 Electronic Support Service

mobile_support@us.dell.com

support@us.dell.com

apsupport@dell.com (Asian/Pacific countries only)

support.jp.dell.com (Japan only)

support.euro.dell.com (Europe only)

1 Electronic Quote Service

apmarketing@dell.com (Asian/Pacific countries only)

sales_canada@dell.com (Canada only)

AutoTech Service

Dell's automated technical support service—AutoTech—provides recorded answers to the questions most frequently asked by Dell customers about their portable and desktop computers.

When you call AutoTech, use your touch-tone telephone to select the subjects that correspond to your questions.

The AutoTech service is available 24 hours a day, 7 days a week. You can also access this service through the technical support service. For the telephone number to call, see the [contact numbers](#) for your region.

Automated Order-Status Service

To check on the status of any Dell™ products that you have ordered, you can go to support.dell.com, or you can call the automated order-status service. A recording prompts you for the information needed to locate and report on your order. For the telephone number to call, see the [contact numbers](#) for your region.

Support Service

Dell's support service is available 24 hours a day, 7 days a week, to answer your questions about Dell hardware. Our support staff uses computer-based diagnostics to provide fast, accurate answers.

To contact Dell's support service, see "[Obtaining Assistance](#)" and then call the number for your country as listed in [Contacting Dell](#).

Problems With Your Order

If you have a problem with your order, such as missing parts, wrong parts, or incorrect billing, contact Dell for customer assistance. Have your invoice or packing slip handy when you call. For the telephone number to call, see the [contact numbers](#) for your region.

Product Information

If you need information about additional products available from Dell, or if you would like to place an order, visit the Dell website at www.dell.com. For the telephone number to call to speak to a sales specialist, see the [contact numbers](#) for your region.

Returning Items for Warranty Repair or Credit

Prepare all items being returned, whether for repair or credit, as follows:

1. Call Dell to obtain a Return Material Authorization Number, and write it clearly and prominently on the outside of the box.
For the telephone number to call for your region, see [Contacting Dell](#).
2. Include a copy of the invoice and a letter describing the reason for the return.
3. Include a copy of the Diagnostics Checklist (see [Diagnostics Checklist](#)), indicating the tests that you have run and any error messages reported by the Dell Diagnostics (see [Dell Diagnostics](#)).
4. Include any accessories that belong with the item(s) being returned (power cables, software floppy disks, guides, and so on) if the return is for credit.
5. Pack the equipment to be returned in the original (or equivalent) packing materials.

You are responsible for insuring any product returned, and you assume the risk of loss during shipment to Dell. Collect On Delivery (C.O.D.) packages are not accepted.

Returns that are missing any of the preceding requirements will be refused at Dell's receiving dock and returned to you.

Before You Call

NOTE: Have your Express Service Code ready when you call. The code helps Dell's automated-support telephone system direct your call more efficiently.

Remember to fill out the [Diagnostics Checklist](#). If possible, turn on your computer before you call Dell for technical assistance and call from a telephone at or near the computer. You may be asked to type some commands at the keyboard, relay detailed information during operations, or try other troubleshooting steps possible only at the computer itself. Ensure that the computer documentation is available.

 **CAUTION:** Before working inside your computer, read the safety instructions in your *Owner's Manual*.

Diagnostics Checklist
Name:
Date:
Address:
Phone number:
Service Tag (bar code on the back of the computer):
Express Service Code:
Return Material Authorization Number (if provided by Dell support technician):
Operating system and version:
Devices:
Expansion cards:
Are you connected to a network? Yes No
Network, version, and network adapter:
Programs and versions:
See your operating system documentation to determine the contents of the system's start-up files. If the computer is connected to a printer, print each file. Otherwise, record the contents of each file before calling Dell.
Error message, beep code, or diagnostic code:
Description of problem and troubleshooting procedures you performed:

Contacting Dell

To contact Dell electronically, you can access the following websites:

- 1 www.dell.com
- 1 support.dell.com (support)

For specific web addresses for your country, find the appropriate country section in the table below.

 **NOTE:** Toll-free numbers are for use within the country for which they are listed.

 **NOTE:** In certain countries, support specific to Dell XPS™ portable computers is available at a separate telephone number listed for participating countries. If you do not see a telephone number listed that is specific for XPS portable computers, you may contact Dell through the support number listed and your call will be routed appropriately.

When you need to contact Dell, use the electronic addresses, telephone numbers, and codes provided in the following table. If you need assistance in determining which codes to use, contact a local or an international operator.

Country (City) International Access Code Country Code City Code	Department Name or Service Area, Website and E-Mail Address	Area Codes, Local Numbers, and Toll-Free Numbers
Anguilla	General Support	toll-free: 800-335-0031
Antigua and Barbuda	General Support	1-800-805-5924
Argentina (Buenos Aires) International Access Code: 00 Country Code: 54 City Code: 11	Website: www.dell.com.ar	
	E-mail: us_latin_services@dell.com	
	E-mail for desktop and portable computers: la-techsupport@dell.com	
	E-mail for servers and EMC® storage products: la_enterprise@dell.com	
	Customer Care	toll-free: 0-800-444-0730
	Technical Support	toll-free: 0-800-444-0733
	Technical Support Services	toll-free: 0-800-444-0724

	Sales	0-810-444-3355
Aruba	General Support	toll-free: 800-1578
Australia (Sydney)	Website: support.ap.dell.com	
International Access Code: 0011	E-mail: support.ap.dell.com/contactus	
Country Code: 61		
City Code: 2	General Support	13DELL-133355
Austria (Vienna)	Website: support.euro.dell.com	
	E-mail: tech_support_central_europe@dell.com	
	Home/Small Business Sales	0820 240 530 00
	Home/Small Business Fax	0820 240 530 49
International Access Code: 900	Home/Small Business Customer Care	0820 240 530 14
	Preferred Accounts/Corporate Customer Care	0820 240 530 16
Country Code: 43	Support for XPS portable computers only	0820 240 530 81
	Home/Small Business Support for all other Dell computers	0820 240 530 14
City Code: 1	Preferred Accounts/Corporate Support	0660 8779
	Switchboard	0820 240 530 00
Bahamas	General Support	toll-free: 1-866-278-6818
Barbados	General Support	1-800-534-3066
Belgium (Brussels)	Website: support.euro.dell.com	
	Tech Support for XPS portable computers only	02 481 92 96
International Access Code: 00	Tech Support for all other Dell computers	02 481 92 88
Country Code: 32	Tech Support Fax	02 481 92 95
	Customer Care	02 713 15 65
City Code: 2	Corporate Sales	02 481 91 00
	Fax	02 481 92 99
	Switchboard	02 481 91 00
Bermuda	General Support	1-800-342-0671
Bolivia	General Support	toll-free: 800-10-0238
Brazil	Website: www.dell.com/br	
International Access Code: 00	Customer Support, Tech Support	0800 90 3355
Country Code: 55	Technical Support Fax	51 481 5470
	Customer Care Fax	51 481 5480
City Code: 51	Sales	0800 90 3390
British Virgin Islands	General Support	toll-free: 1-866-278-6820
Brunei	Technical Support (Penang, Malaysia)	604 633 4966
	Customer Care (Penang, Malaysia)	604 633 4888
Country Code: 673	Transaction Sales (Penang, Malaysia)	604 633 4955
Canada (North York, Ontario)	Online Order Status: www.dell.ca/ostatus	
	AutoTech (automated Hardware and Warranty Support)	toll-free: 1-800-247-9362
	Customer Service (Home Sales/Small Business)	toll-free: 1-800-847-4096
	Customer Service (med./large business, government)	toll-free: 1-800-326-9463
	Customer Service (printers, projectors, televisions, handhelds, digital jukebox, and wireless)	toll-free: 1-800-847-4096
International Access Code: 011	Hardware Warranty Support (Home Sales/Small Business)	toll-free: 1-800-906-3355
	Hardware Warranty Support (med./large bus., government)	toll-free: 1-800-387-5757
	Hardware Warranty Support (printers, projectors, televisions, handhelds, digital jukebox, and wireless)	1-877-335-5767
	Sales (Home Sales/Small Business)	toll-free: 1-800-387-5752
	Sales (med./large bus., government)	toll-free: 1-800-387-5755
	Spare Parts Sales & Extended Service Sales	1 866 440 3355
Cayman Islands	General Support	1-800-805-7541
Chile (Santiago)		
Country Code: 56	Sales and Customer Support	toll-free: 1230-020-4823
City Code: 2		
	Technical Support website: support.dell.com.cn	
	Technical Support E-mail: cn_support@dell.com	

	Customer Care E-mail: customer_cn@dell.com	
	Technical Support Fax	592 818 1350
	Technical Support (Dell™ Dimension™ and Inspiron)	toll-free: 800 858 2968
	Technical Support (OptiPlex™, Latitude™, and Dell Precision™)	toll-free: 800 858 0950
	Technical Support (servers and storage)	toll-free: 800 858 0960
	Technical Support (projectors, PDAs, switches, routers, and so on)	toll-free: 800 858 2920
	Technical Support (printers)	toll-free: 800 858 2311
China (Xiamen)	Customer Care	toll-free: 800 858 2060
Country Code: 86	Customer Care Fax	592 818 1308
City Code: 592	Home and Small Business	toll-free: 800 858 2222
	Preferred Accounts Division	toll-free: 800 858 2557
	Large Corporate Accounts GCP	toll-free: 800 858 2055
	Large Corporate Accounts Key Accounts	toll-free: 800 858 2628
	Large Corporate Accounts North	toll-free: 800 858 2999
	Large Corporate Accounts North Government and Education	toll-free: 800 858 2955
	Large Corporate Accounts East	toll-free: 800 858 2020
	Large Corporate Accounts East Government and Education	toll-free: 800 858 2669
	Large Corporate Accounts Queue Team	toll-free: 800 858 2572
	Large Corporate Accounts South	toll-free: 800 858 2355
	Large Corporate Accounts West	toll-free: 800 858 2811
	Large Corporate Accounts Spare Parts	toll-free: 800 858 2621
Colombia	General Support	980-9-15-3978
Costa Rica	General Support	0800-012-0435
	Website: support.euro.dell.com	
Czech Republic (Prague)	E-mail: czech_dell@dell.com	
International Access Code: 00	Technical Support	22537 2727
Country Code: 420	Customer Care	22537 2707
	Fax	22537 2714
	Technical Fax	22537 2728
	Switchboard	22537 2711
	Website: support.euro.dell.com	
Denmark (Copenhagen)	Technical Support for XPS portable computers only	7010 0074
International Access Code: 00	Technical Support for all other Dell computers	7023 0182
Country Code: 45	Customer Care (Relational)	7023 0184
	Home/Small Business Customer Care	3287 5505
	Switchboard (Relational)	3287 1200
	Switchboard Fax (Relational)	3287 1201
	Switchboard (Home/Small Business)	3287 5000
	Switchboard Fax (Home/Small Business)	3287 5001
Dominica	General Support	toll-free: 1-866-278-6821
Dominican Republic	General Support	1-800-148-0530
Ecuador	General Support	toll-free: 999-119
El Salvador	General Support	01-899-753-0777
	Website: support.euro.dell.com	
Finland (Helsinki)	Technical Support	09 253 313 60
International Access Code: 990	Customer Care	09 253 313 38
Country Code: 358	Fax	09 253 313 99
City Code: 9	Switchboard	09 253 313 00
	Website: support.euro.dell.com	
	Home and Small Business	
	Technical Support for XPS portable computers only	0825 387 129
	Technical Support for all other Dell computers	0825 387 270
	Customer Care	0825 823 833
	Switchboard	0825 004 700
	Switchboard (calls from outside of France)	04 99 75 40 00
France (Paris) (Montpellier)	Sales	0825 004 700
International Access Code: 00	Fax	0825 004 701
Country Code: 33		

City Codes: (1) (4)	Fax (calls from outside of France)	04 99 75 40 01
	Corporate	
	Technical Support	0825 004 719
	Customer Care	0825 338 339
	Switchboard	01 55 94 71 00
	Sales	01 55 94 71 00
	Fax	01 55 94 71 01
Germany (Langen) International Access Code: 00 Country Code: 49 City Code: 6103	Website: support.euro.dell.com	
	E-mail: tech_support_central_europe@dell.com	
	Technical Support for XPS portable computers only	06103 766-7222
	Technical Support for all other Dell computers	06103 766-7200
	Home/Small Business Customer Care	0180-5-224400
	Global Segment Customer Care	06103 766-9570
	Preferred Accounts Customer Care	06103 766-9420
	Large Accounts Customer Care	06103 766-9560
	Public Accounts Customer Care	06103 766-9555
	Switchboard	06103 766-7000
Greece International Access Code: 00 Country Code: 30	Website: support.euro.dell.com	
	Technical Support	00800-44 14 95 18
	Gold Service Technical Support	00800-44 14 00 83
	Switchboard	2108129810
	Gold Service Switchboard	2108129811
	Sales	2108129800
	Fax	2108129812
Grenada	General Support	toll-free: 1-866-540-3355
Guatemala	General Support	1-800-999-0136
Guyana	General Support	toll-free: 1-877-270-4609
Hong Kong International Access Code: 001 Country Code: 852	Website: support.ap.dell.com	
	Technical Support E-mail: HK_support@Dell.com	
	Technical Support (Dimension and Inspiron)	2969 3188
	Technical Support (OptiPlex, Latitude, and Dell Precision)	2969 3191
	Technical Support (PowerApp™, PowerEdge™, PowerConnect™, and PowerVault™)	2969 3196
	Customer Care	3416 0910
	Large Corporate Accounts	3416 0907
	Global Customer Programs	3416 0908
	Medium Business Division	3416 0912
	Home and Small Business Division	2969 3105
India	E-mail: india_support_desktop@dell.com india_support_notebook@dell.com india_support_Server@dell.com	
	Technical Support	1600338045 and 1600448046
	Sales (Large Corporate Accounts)	1600 33 8044
	Sales (Home and Small Business)	1600 33 8046
Ireland (Cherrywood) International Access Code: 00 Country Code: 353 City Code: 1	Website: support.euro.dell.com	
	E-mail: dell_direct_support@dell.com	
	Technical Support for XPS portable computers only	1850 200 722
	Technical Support for all other Dell computers	1850 543 543
	U.K. Technical Support (dial within U.K. only)	0870 908 0800
	Home User Customer Care	01 204 4014
	Small Business Customer Care	01 204 4014
	U.K. Customer Care (dial within U.K. only)	0870 906 0010
	Corporate Customer Care	1850 200 982
	Corporate Customer Care (dial within U.K. only)	0870 907 4499
	Ireland Sales	01 204 4444
	U.K. Sales (dial within U.K. only)	0870 907 4000
	Fax/Sales Fax	01 204 0103
Switchboard	01 204 4444	
	Website: support.euro.dell.com	

Italy (Milan) International Access Code: 00 Country Code: 39 City Code: 02	Home and Small Business	
	Technical Support	02 577 826 90
	Customer Care	02 696 821 14
	Fax	02 696 821 13
	Switchboard	02 696 821 12
	Corporate	
	Technical Support	02 577 826 90
	Customer Care	02 577 825 55
Fax	02 575 035 30	
Switchboard	02 577 821	
Jamaica	General Support (dial from within Jamaica only)	1-800-682-3639
Japan (Kawasaki) International Access Code: 001 Country Code: 81 City Code: 44	Website: support.jp.dell.com	
	Technical Support (servers)	toll-free: 0120-198-498
	Technical Support outside of Japan (servers)	81-44-556-4162
	Technical Support (Dimension and Inspiron)	toll-free: 0120-198-226
	Technical Support outside of Japan (Dimension and Inspiron)	81-44-520-1435
	Technical Support (Dell Precision, OptiPlex, and Latitude)	toll-free: 0120-198-433
	Technical Support outside of Japan (Dell Precision, OptiPlex, and Latitude)	81-44-556-3894
	Technical Support (PDAs, projectors, printers, routers)	toll-free: 0120-981-690
	Technical Support outside of Japan (PDAs, projectors, printers, routers)	81-44-556-3468
	Faxbox Service	044-556-3490
	24-Hour Automated Order Service	044-556-3801
	Customer Care	044-556-4240
	Business Sales Division (up to 400 employees)	044-556-1465
	Preferred Accounts Division Sales (over 400 employees)	044-556-3433
	Large Corporate Accounts Sales (over 3500 employees)	044-556-3430
	Public Sales (government agencies, educational institutions, and medical institutions)	044-556-1469
	Global Segment Japan	044-556-3469
Individual User	044-556-1760	
Switchboard	044-556-4300	
Korea (Seoul) International Access Code: 001 Country Code: 82 City Code: 2	E-mail: krsupport@dell.com	
	Support	toll-free: 080-200-3800
	Support (Dimension, PDA, Electronics and Accessories)	toll-free: 080-200-3801
	Sales	toll-free: 080-200-3600
	Fax	2194-6202
	Switchboard	2194-6000
Latin America	Customer Technical Support (Austin, Texas, U.S.A.)	512 728-4093
	Customer Service (Austin, Texas, U.S.A.)	512 728-3619
	Fax (Technical Support and Customer Service) (Austin, Texas, U.S.A.)	512 728-3883
	Sales (Austin, Texas, U.S.A.)	512 728-4397
	SalesFax (Austin, Texas, U.S.A.)	512 728-4600
		or 512 728-3772
Luxembourg International Access Code: 00 Country Code: 352	Website: support.euro.dell.com	
	Support	342 08 08 075
	Home/Small Business Sales	+32 (0)2 713 15 96
	Corporate Sales	26 25 77 81
	Customer Care	+32 (0)2 481 91 19
	Fax	26 25 77 82
Macao Country Code: 853	Technical Support	toll-free: 0800 105
	Customer Service (Xiamen, China)	34 160 910
	Transaction Sales (Xiamen, China)	29 693 115
Malaysia (Penang) International Access Code: 00 Country Code: 60 City Code: 4	Website: support.ap.dell.com	
	Technical Support (Dell Precision, OptiPlex, and Latitude)	toll-free: 1 800 880 193
	Technical Support (Dimension, Inspiron, and Electronics and Accessories)	toll-free: 1 800 881 306
	Technical Support (PowerApp, PowerEdge, PowerConnect, and PowerVault)	toll-free: 1800 881 386
	Customer Care	toll-free: 1800 881 306 (option 6)
	Transaction Sales	toll-free: 1 800 888 202
Corporate Sales	toll-free: 1 800 888 213	

Mexico International Access Code: 00 Country Code: 52	Customer Technical Support	001-877-384-8979 or 001-877-269-3383
	Sales	50-81-8800 or 01-800-888-3355
	Customer Service	001-877-384-8979 or 001-877-269-3383
	Main	50-81-8800 or 01-800-888-3355
Montserrat	General Support	toll-free: 1-866-278-6822
Netherlands Antilles	General Support	001-800-882-1519
Netherlands (Amsterdam) International Access Code: 00 Country Code: 31 City Code: 20	Website: support.euro.dell.com	
	Technical Support for XPS portable computers only	020 674 45 94
	Technical Support for all other Dell computers	020 674 45 00
	Technical Support Fax	020 674 47 66
	Home/Small Business Customer Care	020 674 42 00
	Relational Customer Care	020 674 4325
	Home/Small Business Sales	020 674 55 00
	Relational Sales	020 674 50 00
	Home/Small Business Sales Fax	020 674 47 75
	Relational Sales Fax	020 674 47 50
Switchboard	020 674 50 00	
Switchboard Fax	020 674 47 50	
New Zealand International Access Code: 00 Country Code: 64	Website: support.ap.dell.com E-mail: support.ap.dell.com/contactus General Support	0800 441 567
Nicaragua	General Support	001-800-220-1006
Norway (Lysaker) International Access Code: 00 Country Code: 47	Website: support.euro.dell.com	
	Technical Support for XPS portable computers only	815 35 043
	Technical Support for all other Dell products	671 16882
	Relational Customer Care	671 17575
	Home/Small Business Customer Care	23162298
	Switchboard	671 16800
Fax Switchboard	671 16865	
Panama	General Support	001-800-507-0962
Peru	General Support	0800-50-669
Poland (Warsaw) International Access Code: 011 Country Code: 48 City Code: 22	Website: support.euro.dell.com E-mail: pl_support_tech@dell.com	
	Customer Service Phone	57 95 700
	Customer Care	57 95 999
	Sales	57 95 999
	Customer Service Fax	57 95 806
	Reception Desk Fax	57 95 998
	Switchboard	57 95 999
Portugal International Access Code: 00 Country Code: 351	Website: support.euro.dell.com	
	Technical Support	707200149
	Customer Care	800 300 413
	Sales	800 300 410 or 800 300 411 or 800 300 412 or 21 422 07 10
Fax	21 424 01 12	
Puerto Rico	General Support	1-800-805-7545
St. Kitts and Nevis	General Support	toll-free: 1-877-441-4731
St. Lucia	General Support	1-800-882-1521
St. Vincent and the Grenadines	General Support	toll-free: 1-877-270-4609
Singapore (Singapore) International Access Code:	Website: support.ap.dell.com	
	Technical Support (Dimension, Inspiron, and Electronics and Accessories) Technical Support (OptiPlex, Latitude, and Dell Precision)	toll-free: 1800 394 7430 toll-free: 1800 394 7488

005 Country Code: 65	Technical Support (PowerApp, PowerEdge, PowerConnect, and PowerVault)	toll-free: 1800 394 7478
	Customer Care	toll-free: 1 800 394 7430 (option 6)
	Transaction Sales	toll-free: 1 800 394 7412
	Corporate Sales	toll-free: 1 800 394 7419
Slovakia (Prague) International Access Code: 00 Country Code: 421	Website: support.euro.dell.com	
	E-mail: czech_dell@dell.com	
	Technical Support	02 5441 5727
	Customer Care	420 22537 2707
	Fax	02 5441 8328
	Tech Fax	02 5441 8328
	Switchboard (Sales)	02 5441 7585
South Africa (Johannesburg) International Access Code: 09/091 Country Code: 27 City Code: 11	Website: support.euro.dell.com	
	E-mail: dell_za_support@dell.com	
	Gold Queue	011 709 7713
	Technical Support	011 709 7710
	Customer Care	011 709 7707
	Sales	011 709 7700
	Fax	011 706 0495
	Switchboard	011 709 7700
Southeast Asian and Pacific Countries	Technical Support, Customer Service, and Sales (Penang, Malaysia)	604 633 4810
Spain (Madrid) International Access Code: 00 Country Code: 34 City Code: 91	Website: support.euro.dell.com	
	Home and Small Business	
	Technical Support	902 100 130
	Customer Care	902 118 540
	Sales	902 118 541
	Switchboard	902 118 541
	Fax	902 118 539
	Corporate	
	Technical Support	902 100 130
	Customer Care	902 115 236
	Switchboard	91 722 92 00
	Fax	91 722 95 83
Sweden (Upplands Vasby) International Access Code: 00 Country Code: 46 City Code: 8	Website: support.euro.dell.com	
	Technical Support for XPS portable computers only	0771 340 340
	Technical Support for all other Dell products	08 590 05 199
	Relational Customer Care	08 590 05 642
	Home/Small Business Customer Care	08 587 70 527
	Employee Purchase Program (EPP) Support	20 140 14 44
	Technical Support Fax	08 590 05 594
Sales	08 590 05 185	
Switzerland (Geneva) International Access Code: 00 Country Code: 41 City Code: 22	Website: support.euro.dell.com	
	E-mail: Tech_support_central_Europe@dell.com	
	Technical Support for XPS portable computers only	0848 33 88 57
	Technical Support (Home and Small Business) for all other Dell products	0844 811 411
	Technical Support (Corporate)	0844 822 844
	Customer Care (Home and Small Business)	0848 802 202
	Customer Care (Corporate)	0848 821 721
	Fax	022 799 01 90
	Switchboard	022 799 01 01
Taiwan International Access Code: 002 Country Code: 886	Website: support.ap.dell.com	
	E-mail: ap_support@dell.com	
	Technical Support (OptiPlex, Latitude, Inspiron, Dimension, and Electronics and Accessories)	toll-free: 00801 86 1011
	Technical Support (PowerApp, PowerEdge, PowerConnect, and PowerVault)	toll-free: 00801 60 1256
	Customer Care	toll-free: 00801 60 1250 (option 5)
	Transaction Sales	toll-free: 00801 65 1228
	Corporate Sales	toll-free: 00801 651 227
	Website: support.ap.dell.com	

Thailand International Access Code: 001 Country Code: 66	Technical Support (OptiPlex, Latitude, and Dell Precision)	toll-free: 1800 0060 07	
	Technical Support (PowerApp, PowerEdge, PowerConnect, and PowerVault)	toll-free: 1800 0600 09	
	Customer Care	toll-free: 1800 006 007 (option 7)	
	Corporate Sales	toll-free: 1800 006 009	
	Transaction Sales	toll-free: 1800 006 006	
Trinidad/Tobago	General Support	1-800-805-8035	
Turks and Caicos Islands	General Support	toll-free: 1-866-540-3355	
U.K. (Bracknell) International Access Code: 00 Country Code: 44 City Code: 1344	Website: support.euro.dell.com		
	Customer Care website: support.euro.dell.com/uk/en/ECare/Form/Home.asp		
	E-mail: dell_direct_support@dell.com		
	Technical Support (Corporate/Preferred Accounts/PAD [1000+ employees])	0870 908 0500	
	Technical Support for XPS portable computers only	0870 366 4180	
	Technical Support (direct and general) for all other products	0870 908 0800	
	Global Accounts Customer Care	01344 373 186	
	Home and Small Business Customer Care	0870 906 0010	
	Corporate Customer Care	01344 373 185	
	Preferred Accounts (500-5000 employees) Customer Care	0870 906 0010	
	Central Government Customer Care	01344 373 193	
	Local Government & Education Customer Care	01344 373 199	
	Health Customer Care	01344 373 194	
	Home and Small Business Sales	0870 907 4000	
	Corporate/Public Sector Sales	01344 860 456	
Home and Small Business Fax	0870 907 4006		
Uruguay	General Support	toll-free: 000-413-598-2521	
U.S.A. (Austin, Texas) International Access Code: 011 Country Code: 1	Automated Order-Status Service	toll-free: 1-800-433-9014	
	AutoTech (portable and desktop computers)	toll-free: 1-800-247-9362	
	Hardware and Warranty Support (Dell TV, Printers, and Projectors) for Relationship customers	toll-free 1-877-459-7298	
	Consumer (Home and Home Office) Support for all other Dell products	toll-free: 1-800-624-9896	
	Customer Service	toll-free: 1-800-624-9897	
	Employee Purchase Program (EPP) Customers	toll-free: 1-800-695-8133	
	Financial Services website: www.dellfinancialservices.com		
	Financial Services (lease/loans)	toll-free: 1-877-577-3355	
	Financial Services (Dell Preferred Accounts [DPA])	toll-free: 1-800-283-2210	
	Business		
	Customer Service and Support	toll-free: 1-800-456-3355	
	Employee Purchase Program (EPP) Customers	toll-free: 1-800-695-8133	
	Printers and Projectors Support	toll-free: 1-877-459-7298	
	Public (government, education, and healthcare)		
	Customer Service and Support	toll-free: 1-800-456-3355	
	Employee Purchase Program (EPP) Customers	toll-free: 1-800-695-8133	
	Dell Sales	toll-free: 1-800-289-3355 or toll-free: 1-800-879-3355	
	Dell Outlet Store (Dell refurbished computers)	toll-free: 1-888-798-7561	
	Software and Peripherals Sales	toll-free: 1-800-671-3355	
	Spare Parts Sales	toll-free: 1-800-357-3355	
	Extended Service and Warranty Sales	toll-free: 1-800-247-4618	
	Fax	toll-free: 1-800-727-8320	
	Dell Services for the Deaf, Hard-of-Hearing, or Speech-Impaired	toll-free: 1-877-DELLTTY (1-877-335-5889)	
	U.S. Virgin Islands	General Support	1-877-673-3355
	Venezuela	General Support	8001-3605

Using the Keyboard and Touch Pad

Dell Precision™ M90 User's Guide

- [Numeric Keypad](#)
- [Key Combinations](#)
- [Touch Pad](#)

Numeric Keypad



The numeric keypad functions like the numeric keypad on an external keyboard. Each key on the keypad has multiple functions. The keypad numbers and symbols are marked in blue on the right of the keypad keys. To type a number or symbol, press <Fn> and the desired key after enabling the keypad.

- 1 To enable the keypad, press <Num Lk>. The  light indicates that the keypad is active.
- 1 To disable the keypad, press <Num Lk> again.

Key Combinations

System Functions

<Ctrl><Shift><Esc>	Opens the Task Manager window.
--------------------	---------------------------------------

Battery

<Fn><F3>	Displays the Dell™ QuickSet Battery Meter. For more information about the Battery Meter, see Dell™ QuickSet Battery Meter .
----------	---

CD or DVD Tray

<Fn><F10>	Ejects the tray out of the drive (if Dell QuickSet is installed). For more information about Dell QuickSet, see Dell™ QuickSet .
-----------	--

Display Functions

<Fn><F8>	Displays a list of icons representing all currently available display options (for example, display only, external monitor or projector only, both display and projector, and so on). Highlight the icon that represents the desired state to switch to that option.
<Fn><F7>	Scales between wide-screen and standard aspect ratio video resolutions.
<Fn> and up-arrow key	Increases brightness on the integrated display only (not on an external monitor).

<Fn> and down-arrow key	Decreases brightness on the integrated display only (not on an external monitor).
-------------------------	---

Wireless Networking and Bluetooth® Wireless Technology Function

<Fn><F2>	Enables and disables wireless networking and Bluetooth wireless technology.
----------	---

Power Management

<Fn><Esc>	Activates a power management mode. You can reprogram this keyboard shortcut to activate a different power management mode using the Advanced tab in the Power Options Properties window. See Power Management Modes .
<Fn><F1>	Puts the system into hibernate mode (if Dell QuickSet is installed). For more information, see Dell™ QuickSet .

Speaker Functions

<Fn><Page Up>	Increases the volume of the integrated speakers and external speakers, if attached.
<Fn><Page Dn>	Decreases the volume of the integrated speakers and external speakers, if attached.
<Fn><End>	Enables and disables the integrated speakers and external speakers, if attached.

Microsoft® Windows® Logo Key Functions

Windows logo key and <m>	Minimizes all open windows.
Windows logo key and <Shift><m>	Restores all minimized windows. This command functions as a toggle to restore all minimized windows following the use of the Windows logo key and <m> key combination.
Windows logo key and <e>	Runs Windows Explorer.
Windows logo key and <r>	Opens the Run dialog box.
Windows logo key and <f>	Opens the Search Results dialog box.
Windows logo key and <Ctrl><f>	Opens the Search Results-Computer dialog box (if the computer is connected to a network).
Windows logo key and <Pause>	Opens the System Properties dialog box.

To adjust keyboard operation, such as the character repeat rate, open the Control Panel, click **Printers and Other Hardware**, and click **Keyboard**. For information about the Control Panel, see the Windows Help and Support Center. To access the Help and Support Center, see [Windows Help and Support Center](#).

Touch Pad

The touch pad detects the pressure and movement of your finger to allow you to move the cursor on the display. Use the touch pad and touch pad buttons as you would use a mouse.

- 1 To move the cursor, lightly slide your finger over the touch pad.

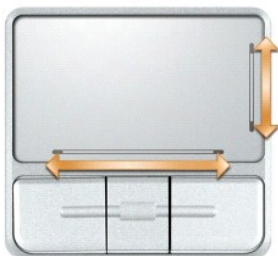

- 1 To select an object, position the cursor on the object and lightly tap once on the surface of the touch pad or use your thumb to press the left touch-pad button.
- 1 To select and move (or drag) an object, position the cursor on the object and tap twice on the touch pad. On the second tap, leave your finger on the touch pad and move the selected object by sliding your finger over the surface.
- 1 To double-click an object, position the cursor on the object and tap twice on the touch pad or use your thumb to press the left touch-pad button twice.

The touch pad has silk screening on the right side and the bottom to indicate scrolling abilities. Scrolling is enabled by default. To disable this feature, modify the mouse properties within the Control Panel.

 **NOTE:** The scroll zones may not work with all applications. For the scroll zones to function properly, the application being used must support the touch pad scroll feature.

Customizing the Touch Pad

You can use the **Mouse Properties** window to disable the touch pad and track stick or adjust their settings.

1. You can use the **Mouse Properties** window to disable the touch pad or adjust their settings. Open the Control Panel, click **Printers and Other Hardware**, and then click **Mouse**. For information about the Control Panel, see the Windows Help and Support Center. To access the Help and Support Center, see [Windows Help and Support Center](#).
2. In the **Mouse Properties** window, click the **Touch Pad** tab to adjust touch pad settings.
3. Click **OK** to save the settings and close the window.

[Back to Contents Page](#)

[Back to Contents Page](#)

Using Multimedia

Dell Precision™ M90 User's Guide

- [Playing CDs or DVDs](#)
 - [Adjusting the Volume](#)
 - [Adjusting the Picture](#)
 - [Connecting Your Computer to a TV or Audio Device](#)
-

Playing CDs or DVDs

- ➔ **NOTICE:** Do not press down on the CD or DVD tray when you open or close it. Keep the tray closed when you are not using the drive.
- ➔ **NOTICE:** Do not move the computer while playing CDs or DVDs.

1. Press the eject button on the front of the drive.
2. Pull out the tray.



3. Place the disc, label side up, in the center of the tray and snap the disc onto the spindle.

 **NOTE:** If you use a module that shipped with another computer, you need to install the drivers and software necessary to play DVDs or write data. For more information, see the *Drivers and Utilities* CD (the CD is optional and may not be available for your computer or in certain countries).

4. Push the tray back into the drive.

To format CDs for storing data, to create music CDs, or to copy CDs, see the CD software that came with your computer.

 **NOTE:** Ensure that you follow all copyright laws when you create CDs.





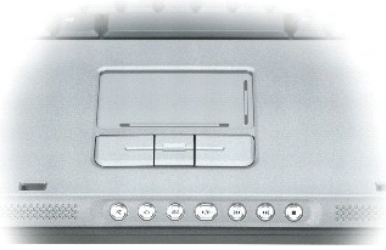

For more information on playing CDs or DVDs, click **Help** on the CD or DVD player (if available).

Adjusting the Volume

 **NOTE:** When the speakers are muted, you do not hear the CD or DVD playing.

To adjust the speaker volume when playing a CD or DVD, use the media control buttons on the front of the computer.



	Mute the sound.
	Turn the volume down.
	Turn the volume up.
	Play or pause.
	Play the previous track.
	Play the next track.
	Stop.

You can also adjust the volume with the **Volume Control** option through the **Start** menu.

1. Click **Start**→ **All Programs**→ **Accessories**→ **Entertainment**→ **Volume Control**.
2. Click and drag the bar in the **Volume Control** column and slide it up or down to increase or decrease the volume.

For more information on volume control options, click **Help** in the **Volume Control** window.

The Volume Meter displays the current volume level, including mute, on your computer. Either click the  icon in the taskbar and select or deselect **Disable On Screen Volume Meter**, or press the volume control buttons to enable or disable the Volume Meter on the screen.

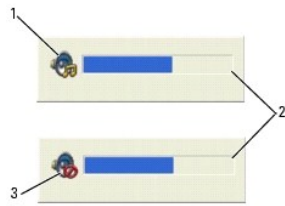

1	volume icon	2	Volume Meter	3	mute icon
---	-------------	---	--------------	---	-----------

When the meter is enabled, adjust the volume with the volume control buttons or by pressing the following keys:

- 1 Press <Fn> <PageUp> to increase volume.
- 1 Press <Fn> <PageDn> to decrease volume.
- 1 Press <Fn> <End> to mute volume.

For more information about QuickSet, right-click the  icon in the taskbar and click **Help**.

Adjusting the Picture

If an error message notifies you that the current resolution and color depth are using too much memory and preventing DVD playback, adjust the display properties.

1. Click **Start**→ **Control Panel**→ **Appearance and Themes**→ **Change the screen resolution**.
2. Click and drag the bar in **Screen resolution** to change the setting to **1024 by 768 pixels**.
3. Click the drop-down menu under **Color quality**, and then click **Medium (16 bit)**→ **OK**.

Connecting Your Computer to a TV or Audio Device

NOTE: Video and audio cables for connecting your computer to a TV or other audio device may not be included with your computer. Cables and TV/digital audio adapter cables are available for purchase from Dell.

Your computer has an S-video TV-out connector that, together with a standard S-video cable, a composite video adapter cable, or a component video adapter cable (available from Dell), enable you to connect the computer to a TV.

Your TV has either an S-video input connector, a composite video-input connector, or a component video-input connector. Depending on what type of connector is available on your TV, you can use a commercially available S-video cable, composite video cable, or component video cable to connect your computer to your TV.

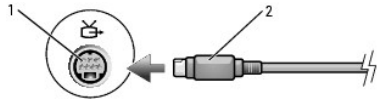

1	S-video TV-out connector	2	S-video connector
---	--------------------------	---	-------------------

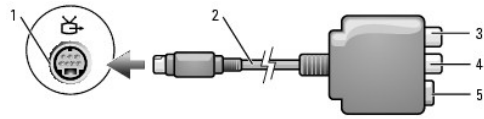

1	S-video TV-out connector	3	S/PDIF digital audio connector	5	S-video connector
2	composite video adapter	4	composite video-output connector		

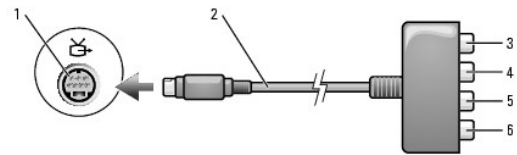

1	S-video TV-out connector	3	S/PDIF digital audio connector	5	Pb (blue) component video-output connector
2	component video adapter	4	Pr (red) component video-output connector	6	Y (green) component video-output connector

It is recommended that you connect video and audio cables to your computer in one of the following combinations.

NOTE: See the diagrams at the beginning of each subsection to help you determine which method of connection you should use.

- 1 [S-video and standard audio](#)
- 1 [Composite video and standard audio](#)
- 1 [Component-out video and standard audio](#)

When you finish connecting the video and audio cables between your computer and your TV, you must enable your computer to work with the TV. See [Enabling the Display Settings for a TV](#) to ensure that the computer recognizes and works properly with the TV. Additionally, if you are using S/PDIF digital audio, see [Enabling S/PDIF Digital Audio](#).

S-Video and Standard Audio

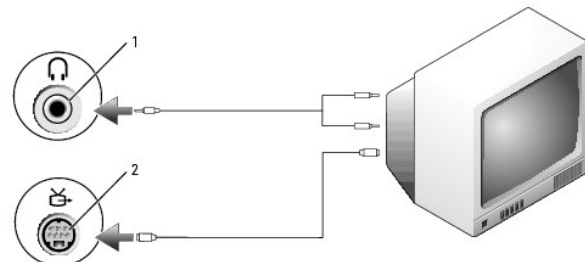

1	audio connector	2	S-video TV-out connector		
---	-----------------	---	--------------------------	--	--

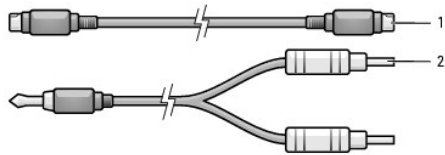

1	standard S-video cable	2	standard audio cable		
---	------------------------	---	----------------------	--	--

1. Turn off the computer and the TV and/or audio device that you want to connect.

NOTE: You can connect an S-video cable directly to the S-video TV-out connector on the computer (without the TV/digital audio adapter cable) if your TV or audio device supports S-video but not S/PDIF digital audio.

2. Plug one end of the S-video cable into the S-video output connector on the computer.
3. Plug the other end of the S-video cable into the S-video input connector on your TV.
4. Plug the single-connector end of the audio cable into the headphone connector on your computer.
5. Plug the two RCA connectors on the other end of the audio cable into the audio input connectors on your TV or other audio device.
6. Turn on the TV and any audio device that you connected (if applicable), and then turn on the computer.
7. See [Enabling the Display Settings for a TV](#) to ensure that the computer recognizes and works properly with the TV.

S-Video and S/PDIF Digital Audio

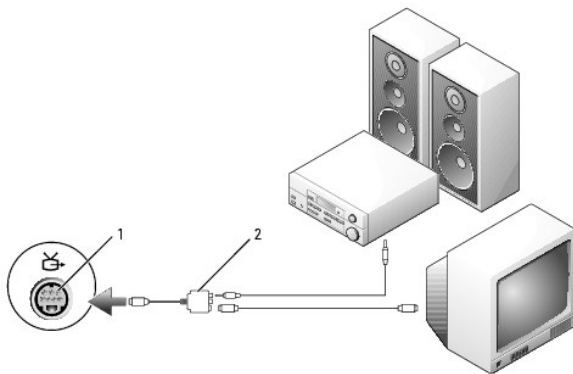

1	S-video TV-out connector	2	composite video adapter		
---	--------------------------	---	-------------------------	--	--

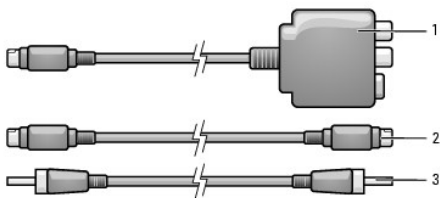

1	composite video adapter	2	S-video cable	3	S/PDIF digital audio cable
---	-------------------------	---	---------------	---	----------------------------

1. Turn off the computer and the TV and/or the audio device that you want to connect.
2. Connect the composite video adapter to the S-video TV-out connector on your computer.
3. Plug one end of the S-video cable into the S-video output connector on the composite video adapter.

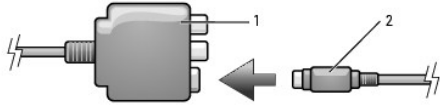

1	composite video adapter	2	S-video cable		
---	-------------------------	---	---------------	--	--

4. Plug the other end of the S-video cable into the S-video input connector on the TV.
5. Plug one end of the S/PDIF digital audio cable into the digital audio connector on the composite video adapter cable.

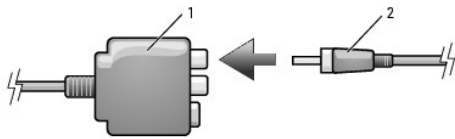

1	composite video adapter	2	S/PDIF digital audio cable		
---	-------------------------	---	----------------------------	--	--

6. Plug the other end of the S/PDIF digital audio cable into the audio input connector on your TV or audio device.
7. Turn on the TV, turn on any audio device that you connected (if applicable), and then turn on the computer.
8. See [Enabling the Display Settings for a TV](#) to ensure that the computer recognizes and works properly with the TV.

Composite Video and Standard Audio

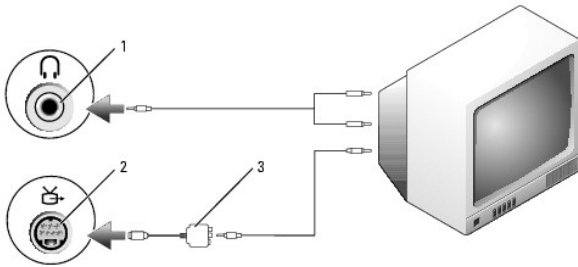

1	audio input connector	2	S-video TV-out connector	3	composite video adapter
---	-----------------------	---	--------------------------	---	-------------------------

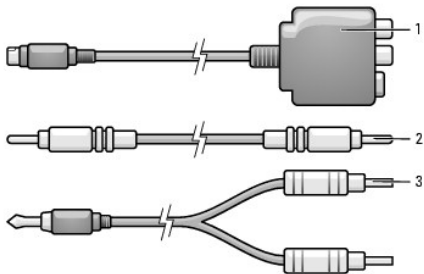

1	composite video adapter	2	composite video cable	3	standard audio cable
---	-------------------------	---	-----------------------	---	----------------------

1. Turn off the computer and the TV and/or audio device that you want to connect.
2. Connect the composite video adapter to the S-video TV-out connector on your computer.
3. Plug one end of the composite video cable into the composite video-output connector on the composite video adapter.

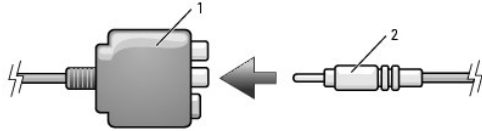

1	composite video adapter	2	composite video cable		
---	-------------------------	---	-----------------------	--	--

4. Plug the other end of the composite video cable into the composite video-input connector on the TV.
5. Plug the single-connector end of the audio cable into the headphone connector on the computer.
6. Plug the two RCA connectors on the other end of the audio cable in to the audio input connectors on your TV or other audio device.
7. Turn on the TV, turn on any audio device that you connected (if applicable), and then turn on the computer.
8. See [Enabling the Display Settings for a TV](#) to ensure that the computer recognizes and works properly with the TV.

Composite Video and S/PDIF Digital Audio

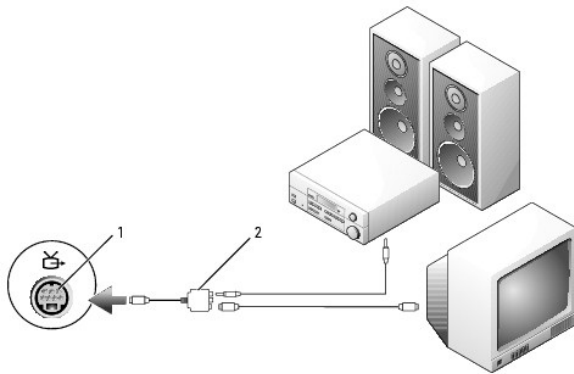

1	S-video TV-out connector	2	composite video adapter		
---	--------------------------	---	-------------------------	--	--

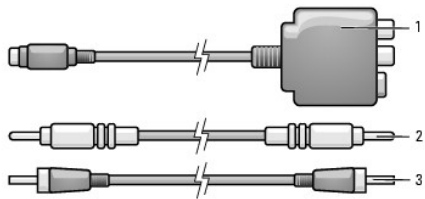

1	composite video adapter	2	composite video cable	3	standard audio cable
---	-------------------------	---	-----------------------	---	----------------------

1. Turn off the computer and the TV and/or audio device that you want to connect.
2. Connect the composite video adapter to the S-video TV-out connector on the computer.
3. Plug one end of the composite video cable into the composite video-input connector on the composite video adapter.

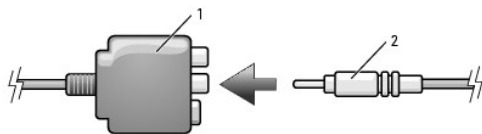

1	composite video adapter	2	composite video cable		
---	-------------------------	---	-----------------------	--	--

4. Plug the other end of the composite video cable into the composite video-input connector on the TV.

- Plug one end of the S/PDIF digital audio cable in to the S/PDIF audio connector on the composite video adapter.

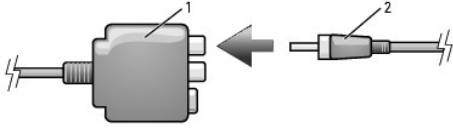

1	composite video adapter	2	S/PDIF digital audio cable		
---	-------------------------	---	----------------------------	--	--

- Plug the other end of the digital audio cable into the S/PDIF input connector on your TV or other audio device.
- Turn on the TV, turn on any audio device that you connected (if applicable), and then turn on the computer.
- See [Enabling the Display Settings for a TV](#) to ensure that the computer recognizes and works properly with the TV.

Component Video and Standard Audio

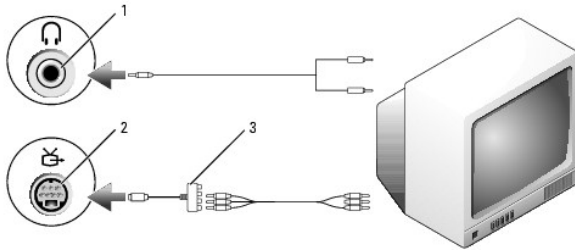

1	S-video TV-out connector	2	component video adapter		
---	--------------------------	---	-------------------------	--	--

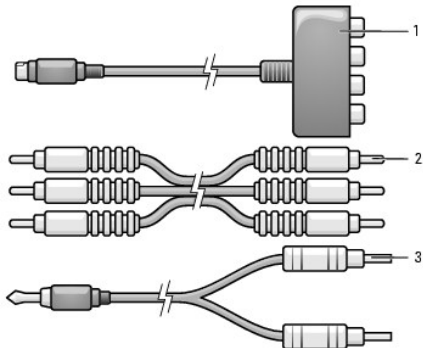

1	component video adapter	2	component video cable	3	standard audio cable
---	-------------------------	---	-----------------------	---	----------------------

- Turn off the computer and the TV and/or audio device that you want to connect.
- Connect the component video adapter to the S-video TV-out connector on your computer.
- Plug all three ends of the component video cable into the component video-output connectors on the component video adapter. Make sure that the red, green, and blue colors of the cable match the corresponding adapter ports.

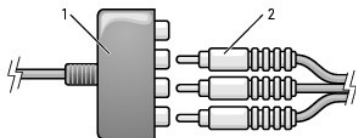

1	component video adapter	2	component video cable		
---	-------------------------	---	-----------------------	--	--

4. Plug all three connectors from the other end of the component video cable into the component video- input connectors on the TV. Make sure that the red, green, and blue colors of the cable match the colors of the TV input connectors.
5. Plug the single-connector end of the audio cable into the headphone connector on the computer.
6. Plug the two RCA connectors on the other end of the audio cable into the audio input connectors on your TV or audio device.
7. Turn on the TV, turn on any audio device that you connected (if applicable), and then turn on the computer.
8. See [Enabling the Display Settings for a TV](#) to ensure that the computer recognizes and works properly with the TV.

Component Video and S/PDIF Digital Audio

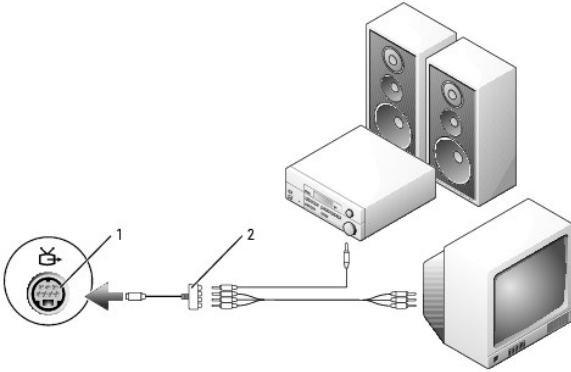

1	S-video TV-out connector	2	component video adapter		
---	--------------------------	---	-------------------------	--	--

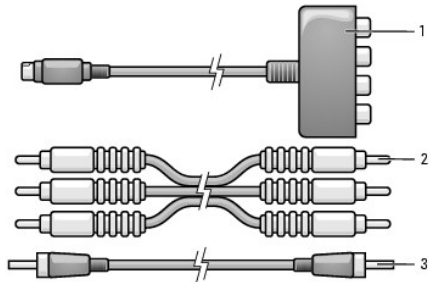

1	component video adapter	2	component video cable	3	standard audio cable
---	-------------------------	---	-----------------------	---	----------------------

1. Turn off the computer and the TV and/or audio device that you want to connect.
2. Connect the component video adapter to the S-video TV-out connector on the computer.
3. Plug all three ends of the component video cable into the component video-output connectors on the component video adapter. Make sure that the red, green, and blue colors of the cable match the corresponding adapter ports.

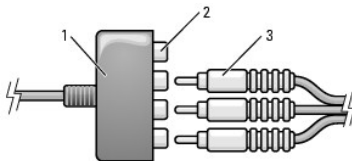

1	component video adapter	2	component video-output connectors	3	component video cable
---	-------------------------	---	-----------------------------------	---	-----------------------

4. Plug all three connectors from the other end of the component video cable into the component video- input connectors on the TV. Make sure that the red, green, and blue colors of the cable match the colors of the TV input connectors.
5. Plug one end of the S/PDIF digital audio cable into the S/PDIF audio connector on the component video adapter.

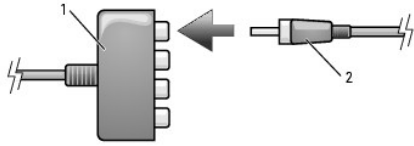

1	component video adapter	2	S/PDIF digital audio cable		
---	-------------------------	---	----------------------------	--	--

6. Plug the other end of the digital audio cable into the S/PDIF input connector on your TV or other audio device.
7. Turn on the TV, turn on any audio device that you connected (if applicable), and then turn on the computer.
8. See [Enabling the Display Settings for a TV](#) to ensure that the computer recognizes and works properly with the TV.

Enabling S/PDIF Digital Audio

If your computer has a DVD drive, you can enable digital audio for DVD playback.

1. Click **Start**, and point to **All Programs**, and click **PowerDVD** to launch the **Cyberlink PowerDVD** application.
2. Insert a DVD into the DVD drive.
If the DVD begins playing, click the stop button.
3. Click the **Settings** option.
4. Click the **DVD** option.
5. Click the **DVD Audio Setting** icon.
6. Click the arrows beside the **Speaker Configuration** setting to scroll through the options, and select the **SPDIF** option.
7. Click the **Back** button once, and then click the **Back** button again to return to the main menu screen.

Enabling S/PDIF in the Windows Audio Driver

1. Double-click the speaker icon in the Windows notification area.
2. Click the **Options** menu and then click **Advanced Controls**.
3. Click **Advanced**.
4. Click **S/PDIF Interface**.
5. Click **Close**.
6. Click **OK**.

Setting Up the Cyberlink (CL) Headphones

 **NOTE:** The CL headphone feature is available only if your computer has a DVD drive.

If your computer has a DVD drive, you can enable digital audio for DVD playback.

1. Click **Start**, point to **All Programs**, and click **PowerDVD** to launch the **Cyberlink PowerDVD** program.
2. Insert a DVD into the DVD drive.
If the DVD begins playing, click the stop button.
3. Click the **Settings** option.

4. Click the **DVD** option.
5. Click the **DVD Audio Setting** icon.
6. Click the arrows beside the **Speaker Configuration** setting to scroll through the options, and select the **Headphones** option.
7. Click the arrows beside the **Audio listening mode** setting to scroll through the options, and select the **CL Headphone** option.
8. Click the arrows beside the **Dynamic range compression** option to select the most suitable option.
9. Click the **Back** button once, and then click the **Back** button again to return to the main menu screen.

Enabling the Display Settings for a TV

Video Controller

 **NOTE:** To ensure that the display options appear correctly, connect the TV to the computer before you enable the display settings.

1. Click the **Start** button, point to **Settings**, and then click **Control Panel**.
2. Double-click **Display** and click the **Settings** tab.
3. Click **Advanced**.
4. Click the tab for your video card.

 **NOTE:** To determine the type of video card installed in your computer, see the Windows Help and Support Center. To access the Help and Support Center, click **Start**→**Help and Support**. Under **Pick a Task**, click **Use Tools to view your computer information and diagnose problems**. Then, under **My Computer Information**, select **Hardware**.

5. In the display devices section, select the appropriate option for using either a single display or multiple displays, ensuring that the display settings are correct for your selection.

[Back to Contents Page](#)

Using Networks

Dell Precision™ M90 User's Guide

- [Physically Connecting to a Network or Broadband Modem](#)
 - [Network Setup Wizard](#)
 - [Wireless Local Area Network \(WLAN\)](#)
 - [Connecting to a WLAN](#)
 - [Mobile Broadband](#)
 - [Internet Connection Firewall](#)
-

Physically Connecting to a Network or Broadband Modem

Before you connect your computer to a network, the computer must have a network adapter installed and a network cable connected to it.

To connect a network cable:

1. Connect the network cable to the network adapter connector on the back of your computer.

 **NOTE:** Insert the cable connector until it clicks into place, and then gently pull the cable to ensure that it is securely attached.

2. Connect the other end of the network cable to a network connection device or a network wall connector.

 **NOTE:** Do not use a network cable with a telephone wall connector.



Network Setup Wizard

The Microsoft® Windows® XP operating system provides a Network Setup Wizard to guide you through the process of sharing files, printers, or an Internet connection between computers in a home or small office.

1. Click the **Start** button, point to **All Programs**→ **Accessories**→ **Communications**, and then click **Network Setup Wizard**.
2. On the welcome screen, click **Next**.
3. Click **Checklist for creating a network**.

 **NOTE:** Selecting the connection method labeled **This computer connects directly to the Internet** enables the integrated firewall provided with Windows XP Service Pack 2 (SP2).

4. Complete the checklist.
 5. Return to the Network Setup Wizard and follow the instructions on the screen.
-

Wireless Local Area Network (WLAN)

A WLAN is a series of interconnected computers that communicate with each other over the air waves rather than through a network cable connected to each computer. In a WLAN, a radio communications device called an access point or wireless router connects network computers and provides Internet, or network, access. The access point or wireless router and the wireless network card in the computer communicate by broadcasting data from their antennas over the air waves.

What You Need to Establish a WLAN

Before you can set up a WLAN, you need:

- 1 High-speed (broadband) Internet access (such as cable or DSL)
- 1 A broadband modem that is connected and working
- 1 A wireless router or access point
- 1 A wireless network card for each computer that you want to connect to your WLAN
- 1 Network cable with the network (RJ-45) connector

Checking Your Wireless Network Card

Depending on what you selected when you purchased your computer, the computer has a variety of configurations. To confirm that your computer has a wireless network card and to determine the type of card, use one of the following:

- 1 The **Start** button and the **Connect To** option
- 1 Microsoft® Windows® Help and Support Center
- 1 The order confirmation for your computer

Start Button and Connect To Option

1. Click the **Start** button.
2. Point to **Connect To**, and then click **Show all connections**.

If **Wireless Network Connection** does not appear under **LAN or High-Speed Internet**, you may not have a wireless network card.

If **Wireless Network Connection** appears, you have a wireless network card. To view detailed information about the wireless network card:

1. Right-click **Wireless Network Connection**.
2. Click **Properties**. The **Wireless Network Connection Properties** window appears. The wireless network card's name and model number are listed on the **General** tab.

 **NOTE:** If your computer is set to the **Classic Start** menu option, you can view network connections by clicking the **Start** button, pointing to **Settings**, and then pointing to **Network Connections**. If **Wireless Network Connection** does not appear, you may not have a wireless network card.

Order Confirmation

The order confirmation that you received when you ordered your computer lists the hardware and software that shipped with your computer.

Setting Up a New WLAN

Connecting a Wireless Router and a Broadband Modem

1. Contact your Internet service provider (ISP) to obtain specific information about the connection requirements for your broadband modem.
2. Ensure that you have wired Internet access through your broadband modem before you attempt to set up a wireless Internet connection. See [Physically Connecting to a Network or Broadband Modem](#).
3. Install any software required for your wireless router. Your wireless router may have been shipped with an installation CD. Such CDs usually contain installation and troubleshooting information. Install the required software according to the manufacturer's instructions.
4. Shut down your computer and any other wireless-enabled computers in the vicinity through the **Start** menu.

5. Disconnect your broadband modem power cable from the electrical outlet.
6. Disconnect the network cable from the computer and the modem.

 **NOTE:** Wait for a minimum of 5 minutes after disconnecting your broadband modem before you continue with the network setup.

7. Disconnect the AC adapter cable from your wireless router to ensure that there is no power connected to the router.
8. Insert a network cable into the network (RJ-45) connector on the unpowered broadband modem.
9. Connect the other end of the network cable into the Internet network (RJ-45) connector on the unpowered wireless router.
10. Ensure that no network or USB cables, other than the network cable connecting the modem and the wireless router, are connected to the broadband modem.

 **NOTE:** Restart your wireless equipment in the order described below to prevent a potential connection failure.

11. Turn on *ONLY* your broadband modem and wait for at least 2 minutes for the broadband modem to stabilize. After 2 minutes, proceed to [step 12](#).
12. Turn on your wireless router and wait for at least 2 minutes for the wireless router to stabilize. After 2 minutes, proceed to [step 13](#).
13. Start your computer and wait until the boot process completes.
14. See the documentation that came with your wireless router to do the following in order to set up the wireless router:
 1. Establish communication between your computer and your wireless router.
 1. Configure your wireless router to communicate with your broadband router.
 1. Find out your wireless router's broadcast name. The technical term for the name of your router's broadcast name is Service Set Identifier (SSID) or network name.
15. If necessary, configure your wireless network card to connect to the wireless network. See [Connecting to a WLAN](#).

Connecting to a WLAN

 **NOTE:** Before you connect to a WLAN, ensure that you have followed the instructions in [Wireless Local Area Network \(WLAN\)](#).

 **NOTE:** The following networking instructions do not apply to internal cards with Bluetooth[®] wireless technology or cellular products.

This section provides general procedures for connecting to a network via wireless technology. Specific network names and configuration details vary. See [Wireless Local Area Network \(WLAN\)](#) for more information about how to prepare for connecting your computer to a WLAN.

Your wireless network card requires specific software and drivers for connecting to a network. The software is already installed.

 **NOTE:** If the software is removed or corrupted, follow the instructions in the user documentation for your wireless network card. Verify the type of wireless network card installed in your computer and then search for that name on the Dell Support website at support.dell.com. For information on the type of wireless network card that is installed in your computer, see [Checking Your Wireless Network Card](#).

Determining the Wireless Network Device Manager

Depending on the software installed on your computer, different wireless configuration utilities may manage your network devices:

1. Your wireless network card's client utility
1. The Windows XP operating system

To determine which wireless configuration utility is managing your wireless network card:

1. Click the **Start** button, point to **Settings**, and then click **Control Panel**.
2. Double-click **Network Connections**.
3. Right-click the **Wireless Network Connection** icon, and then click **View Available Wireless Networks**.

If the **Choose a wireless network** window states **Windows cannot configure this connection**, the wireless network card's client utility is managing the wireless network card.

If the **Choose a wireless network** window states **Click an item in the list below to connect to a wireless network in range or to get more information**, the Windows XP operating system is managing the wireless network card.

For specific information about the wireless configuration utility installed on your computer, see your wireless network documentation in the Windows Help and Support Center.

To access the Help and Support Center:

1. Click the **Start** button and click **Help and Support**.
2. Under **Pick a Help topic**, click **Dell User and System Guides**.
3. Under **Device Guides**, select the documentation for your wireless network card.

Completing the Connection to the WLAN

When you turn on your computer and a network (for which your computer is not configured) is detected in the area, a pop-up appears near the network icon in the notification area (in the lower-right corner of the Windows desktop).

Follow the instructions provided in any utility prompts that appear on your screen.

Once you have configured your computer for the wireless network that you selected, another pop-up notifies you that your computer is connected to that network.

Thereafter, whenever you log on to your computer within the range of the wireless network that you selected, the same pop-up notifies you of the wireless network connection.

 **NOTE:** If you select a secure network, you must enter a WEP or WPA key when prompted. Network security settings are unique to your network. Dell cannot provide this information.

 **NOTE:** Your computer can take up to 1 minute to connect to the network.

Enabling/Disabling the Wireless Network Card

 **NOTE:** If you are unable to connect to a wireless network, ensure that you have all the components for establishing a WLAN (see [What You Need to Establish a WLAN](#)), and then verify that your wireless network card is enabled by pressing <Fn><F2>.

You can turn your computer's wireless networking function on and off by pressing the <Fn><F2> key combination. If the wireless networking function is turned on, press <Fn><F2> to disable it. If the wireless networking function is turned off, press <Fn><F2> to enable it.

Monitoring the Status of the Wireless Network Card Through Dell™ QuickSet

The wireless activity indicator provides you with an easy way to monitor the status of your computer's wireless devices. Right-click the Dell QuickSet icon in your taskbar to select or deselect **Wireless Activity Indicator Off** to turn the wireless activity indicator on or off.

The wireless activity indicator displays whether your computer's integrated wireless devices are enabled or disabled. When you turn the wireless networking function on or off, the wireless activity indicator changes to display the status.

For more information about the wireless activity indicator, see the *Dell QuickSet Help* file. For information about QuickSet and how to access the *Dell QuickSet Help* file, see [Dell™ QuickSet](#).

Mobile Broadband

Much like a WLAN, a Mobile Broadband network is a series of interconnected computers that communicate with each other through wireless technology. However, a Mobile Broadband network uses cellular technology and therefore provides Internet access in the same varied locations from which cellular telephone service is available. Your computer can maintain the Mobile Broadband network connection regardless of its physical location, as long as the computer remains in the service area of your cellular service provider.

What You Need to Establish a Mobile Broadband Network Connection

To set up a Mobile Broadband network connection, you need:

- 1 A Mobile Broadband ExpressCard

For instructions on using ExpressCards, see [ExpressCards](#). Also see the Quick Start Guide that came with your ExpressCard.

- 1 Activated Mobile Broadband ExpressCard or activated Subscriber Identity Module (SIM) for your service provider.
- 1 The Dell Mobile Broadband Card Utility (already installed on your computer if you purchased the card when you purchased your computer, or on the CD that accompanied your card if purchased separately from your computer)

If the utility is corrupted or deleted from your computer, see the Dell Mobile Broadband Card Utility user's guide for instructions. The user's guide is available through the Windows Help and Support Center (or on the CD that accompanied your card if you purchased it separately from your computer). To access the Help and Support Center, see [Windows Help and Support Center](#).

Checking Your Dell Mobile Broadband Card

Depending on what you selected when you purchased your computer, the computer has a variety of configurations. To determine your computer configuration, see one of the following:

1. Your order confirmation
1. Microsoft® Windows® Help and Support Center

To check your Mobile Broadband card in the Help and Support Center:

1. Click the **Start** button and click **Help and Support**.
2. Under **Pick a task**, click **Use Tools to view your computer information and diagnose problems**.
3. Under **Tools**, click **My Computer Information** and then click **Find information about the hardware installed on this computer**.

On the **My Computer Information - Hardware** screen, you can view the type of Mobile Broadband card installed in your computer as well as other hardware components.

 **NOTE:** The Mobile Broadband card is listed under **Modems**.

Connecting to a Mobile Broadband Network

 **NOTE:** These instructions only apply to Mobile Broadband ExpressCards. They do not apply to internal cards with Bluetooth® wireless technology or WLAN Mini-Cards.

 **NOTE:** Before you connect to the Internet, you must activate Mobile Broadband service through your cellular service provider. For instructions and for additional information about using the Dell Mobile Broadband Card Utility, see the user's guide available through the Windows Help and Support Center. To access the Help and Support Center, see [Windows Help and Support Center](#). The user's guide is also available on the Dell Support website at support.dell.com and on the CD included with your Mobile Broadband card if you purchased the card separately from your computer.

Use the Dell Mobile Broadband Card Utility to establish and manage a Mobile Broadband network connection to the Internet:

1. Click the Dell Mobile Broadband Card Utility icon,  , in the Windows taskbar, to run the utility.
2. Click **Connect**.

 **NOTE:** The **Connect** button changes to the **Disconnect** button.

3. Follow the instructions on the screen to manage the network connection with the utility.

OR

1. Click the **Start** button, point to **All Programs**→ **Dell Wireless**.
2. Click **Dell Wireless Broadband** and follow the instructions on the screen.

Internet Connection Firewall

The Internet Connection Firewall provides basic protection from unauthorized access to the computer while the computer is connected to the Internet. The firewall is automatically enabled when you run the Network Setup Wizard. When the firewall is enabled for a network connection, the firewall icon appears with a red background in the **Network Connections** section of the Control Panel.

Note that enabling the Internet Connection Firewall does not reduce the need for virus-checking software.

For more information, see the Help and Support Center for the Microsoft® Windows® XP operating system. See [Windows Help and Support Center](#).

[Back to Contents Page](#)

[Back to Contents Page](#)

Adding and Replacing Parts

Dell Precision™ M90 User's Guide

Before You Begin	Hinge Cover
Hard Drive	Keyboard
Memory	Coin-Cell Battery
Modem	Optical Drive
Mini-Card	Internal Card With Bluetooth® Wireless Technology

Before You Begin

This chapter provides procedures for removing and installing the components in your computer. Unless otherwise noted, each procedure assumes that the following conditions exist:

- 1 You have performed the steps in [Turning Off Your Computer](#) and [Before Working Inside Your Computer](#).
- 1 You have read the safety information in your Dell™ *Product Information Guide*.
- 1 A component can be replaced or—if purchased separately—installed by performing the removal procedure in reverse order.

Recommended Tools

The procedures in this document may require the following tools:

- 1 Small flat-blade screwdriver
- 1 Phillips screwdriver
- 1 Small plastic scribe
- 1 Flash BIOS update program (see the Dell Support website at support.dell.com)

Turning Off Your Computer

 **NOTICE:** To avoid losing data, save and close any open files and exit any open programs before you turn off your computer.

1. Shut down the operating system:

Save and close any open files, exit any open programs, click **Start**→**Shut Down**→**Shut down**.

The computer turns off after the operating system shutdown process finishes.

2. Ensure that the computer and any attached devices are turned off. If your computer and attached devices did not automatically turn off when you shut down your operating system, press and hold the power button for at least 8–10 seconds until the computer turns off.

Before Working Inside Your Computer

Use the following safety guidelines to help protect your computer from potential damage and to help ensure your own personal safety.

 **CAUTION:** Before you begin any of the procedures in this section, follow the safety instructions in the *Product Information Guide*.

 **CAUTION:** Handle components and cards with care. Do not touch the components or contacts on a card. Hold a card by its edges or by its metal mounting bracket. Hold a component such as a processor by its edges, not by its pins.

 **NOTICE:** Damage due to servicing that is not authorized by Dell is not covered by your warranty.

 **NOTICE:** When you disconnect a cable, pull on its connector or on its strain-relief loop, not on the cable itself. Some cables have a connector with locking tabs; if you are disconnecting this type of cable, press in on the locking tabs before you disconnect the cable. As you pull connectors apart, keep them evenly aligned to avoid bending any connector pins. Also, before you connect a cable, ensure that both connectors are correctly oriented and aligned.

 **NOTICE:** To avoid electrostatic discharge, ground yourself by using a wrist grounding strap or by periodically touching an unpainted metal surface (such as a connector on the back of the computer).

 **NOTICE:** To avoid damaging the computer, perform the following steps before you begin working inside the computer.

1. Ensure that the work surface is flat and clean to prevent the computer cover from being scratched.

2. Turn off your computer. See [Turning Off Your Computer](#).

🔑 **NOTICE:** To disconnect a network cable, first unplug the cable from your computer and then unplug it from the network wall jack.

3. Disconnect any telephone or network cables from the computer.

🔑 **NOTICE:** To avoid damaging the system board, you must remove the battery before you service the computer.

4. Disconnect your computer and all attached devices from their electrical outlets.

5. Remove the battery. Slide and hold the battery-bay latch release on the bottom of the computer, and then remove the battery from the bay.

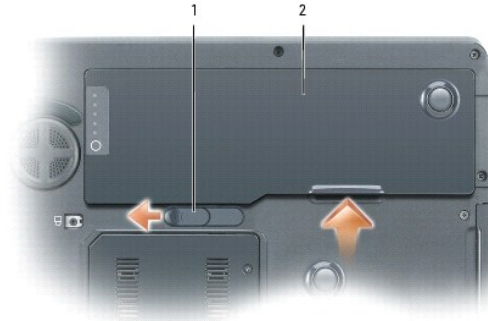

1	battery-bay latch release	2	battery		
---	---------------------------	---	---------	--	--

6. Press the power button to ground the system board.

7. Close the display and turn the computer upside down on a flat work surface.

Hard Drive

⚠️ **CAUTION:** If you remove the hard drive from the computer when the drive is hot, *do not touch* the metal housing of the hard drive.

⚠️ **CAUTION:** Before you begin any of the procedures in the section, follow the safety instructions in the *Product Information Guide*.

🔑 **NOTICE:** To prevent data loss, turn off your computer (see [Turning Off Your Computer](#)) before removing the hard drive. Do not remove the hard drive while the computer is on, in standby mode, or in hibernate mode.

🔑 **NOTICE:** Hard drives are extremely fragile: even a slight bump can damage the drive.

🔑 **NOTICE:** To avoid electrostatic discharge, ground yourself by using a wrist grounding strap or by periodically touching an unpainted metal surface (such as a connector on the back of the computer).

🔑 **NOTICE:** To avoid damaging the system board, you must remove the battery before you begin working inside the computer.

🔧 **NOTE:** Dell does not guarantee compatibility or provide support for hard drives from sources other than Dell.

🔧 **NOTE:** If you are installing a hard drive from a source other than Dell, you need to install an operating system, drivers, and utilities on the new hard drive. See [Restoring Your Operating System](#) and [Reinstalling Drivers and Utilities](#).

To replace the hard drive:

1. Follow the procedures in [Before You Begin](#).

2. Turn the computer over, and remove the hard drive screws.

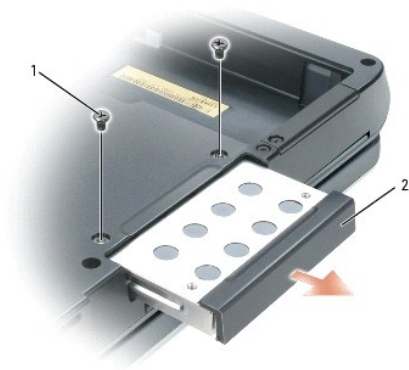

1	hard drive screws (2)	2	hard drive		
---	-----------------------	---	------------	--	--

➡ **NOTICE:** When the hard drive is not in the computer, store it in protective antistatic packaging. See "Protecting Against Electrostatic Discharge" in the *Product Information Guide*.

3. Slide the hard drive out of the computer.
4. Remove the new drive from its packaging.
Save the original packaging for storing or shipping the hard drive.

➡ **NOTICE:** Use firm and even pressure to slide the drive into place. If you use excessive force, you may damage the connector.

5. Slide the hard drive into the bay until it is fully seated.
6. Replace and tighten the screws.
7. If the new hard drive is not already pre-imaged, install the operating system and drivers for your computer. See [Restoring Your Operating System](#) and [Reinstalling Drivers and Utilities](#).

Returning a Hard Drive to Dell

Return your old hard drive to Dell in its original or comparable foam packaging. Otherwise, the hard drive may be damaged in transit.

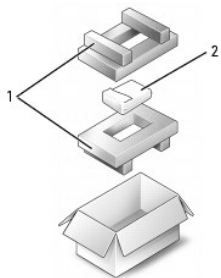

1	foam packaging	2	hard drive		
---	----------------	---	------------	--	--

Memory

You can increase your computer memory by installing memory modules on the system board. See [Specifications](#) for information on the memory supported by your computer. Install only memory modules that are intended for your computer.

🔧 **NOTE:** Memory modules purchased from Dell are covered under your computer warranty.

⚠️ **CAUTION:** Before you begin any of the procedures in this section, follow the safety instructions in the *Product Information Guide*.

➡ **NOTICE:** To avoid electrostatic discharge, ground yourself by using a wrist grounding strap or by periodically touching an unpainted metal surface (such as a connector on the back of the computer).

➔ **NOTICE:** To avoid damaging the system board, you must remove the battery before you begin working inside the computer.

1. Follow the procedures in [Before You Begin](#).
2. Ground yourself by touching one of the metal connectors on the back of the computer.

🔧 **NOTE:** If you leave the area, ground yourself again when you return to the computer.

3. Turn the computer over, loosen the captive screws on the memory module cover, and then remove the cover.

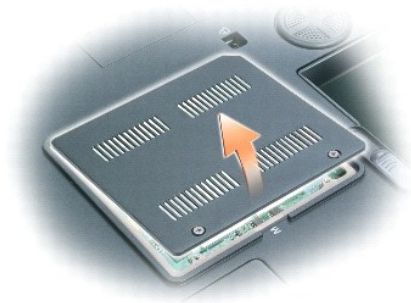

➔ **NOTICE:** To prevent damage to the memory module connector, do not use tools to spread the memory-module securing clips.

4. If you are replacing a memory module, remove the existing module:
 - a. Use your fingertips to carefully spread apart the securing clips on each end of the memory module connector until the module pops up.
 - b. Remove the module from the connector.

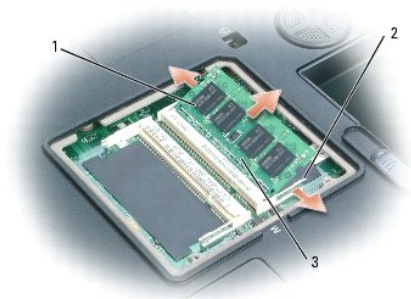

1	memory module	2	securing clips (2 per connector)	3	memory module connector
---	---------------	---	----------------------------------	---	-------------------------

🔧 **NOTE:** If the memory module is not installed properly, the computer may not boot properly. No error message indicates this failure.

5. Ground yourself and install the new memory module:
 - a. Align the notch in the module edge connector with the tab in the connector slot.
 - b. Slide the module firmly into the slot at a 45-degree angle, and rotate the module down until it clicks into place. If you do not feel the click, remove the module and reinstall it.

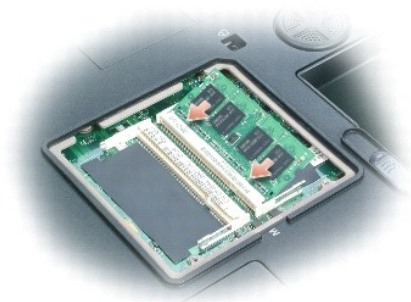

6. Replace the memory module cover.

NOTICE: If the cover is difficult to close, remove the module and reinstall it. Forcing the cover to close may damage your computer.

7. Insert the battery into the battery bay, or connect the AC adapter to your computer and an electrical outlet.
8. Reinstall the hard drive. See [Hard Drive](#).
9. Reinstall the optical drive. See [Optical Drive](#).
10. Turn on the computer.

As the computer boots, it detects the additional memory and automatically updates the system configuration information. If prompted, press <F1> to continue.

To confirm the amount of memory installed in the computer, click **Start**→ **Control Panel**→ **System**.

Modem

CAUTION: Before you begin any of the procedures in this section, follow the safety instructions in the *Product Information Guide*.

NOTICE: To avoid electrostatic discharge, ground yourself by using a wrist grounding strap or by periodically touching an unpainted metal surface (such as a connector on the back of the computer).

NOTICE: To avoid damaging the system board, you must remove the battery before you begin working inside the computer.

1. Follow the procedures in [Before You Begin](#).
2. Turn the computer over and loosen the captive screws from the Mini-Card/modem cover.
3. Place your finger under the cover at the indentation, and lift the cover to remove it.

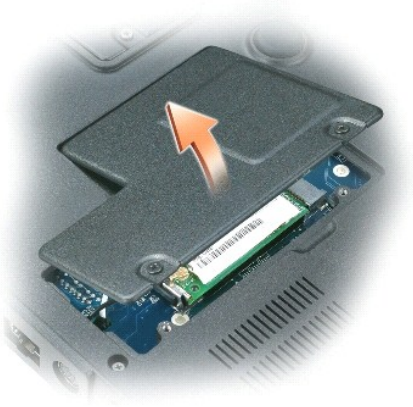

4. Remove the existing modem:
 - a. Remove the screw that secures the modem to the system board, and set the screw aside.
 - b. Pull straight up on the attached pull-tab to lift the modem out of its connector on the system board, and disconnect the modem cable.

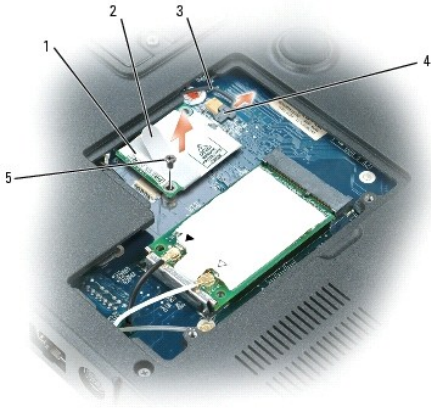

1	modem	3	modem cable	5	modem screw
2	modem pull-tab	4	modem connector on system board		

5. Install the replacement modem:

- a. Connect the modem cable to the modem.

NOTICE: The connectors are keyed to ensure correct insertion. If you feel resistance, check the connectors and realign the card.

- b. Align the modem with the screw holes and press the modem into the connector on the system board.
- c. Replace the screw that secures the modem to the system board.

6. Replace the Mini-Card/modem cover.

Mini-Card

If you ordered a Mini-Card with your computer, the card is already installed.

CAUTION: Before you begin any of the procedures in this section, follow the safety instructions in the *Product Information Guide*.

NOTICE: To avoid electrostatic discharge, ground yourself by using a wrist grounding strap or by periodically touching an unpainted metal surface (such as a connector on the back of the computer).

NOTICE: To avoid damaging the system board, you must remove the battery before you begin working inside the computer.

1. Follow the procedures in [Before You Begin](#).
2. Turn the computer over and loosen the captive screws from the Mini-Card/modem cover.
3. Place your finger under the cover at the indentation, and lift the cover to remove it.



4. If a Mini-Card is not already installed, go to [step 5](#). If you are replacing a Mini-Card, remove the existing card:
 - a. Disconnect the antenna cables from the Mini-Card.



1	antenna connectors (2)	2	Mini-Card	3	Mini-Card connector
---	------------------------	---	-----------	---	---------------------

- b. Release the Mini-Card by pushing the metal securing clips toward the back of the computer until the card pops up slightly.
 - c. Lift the Mini-Card out of its connector.



1	securing clips (2)	2	Mini-Card		
---	--------------------	---	-----------	--	--

NOTICE: The connectors are keyed to ensure correct insertion. If you feel resistance, check the connectors and realign the card.

5. Install the replacement Mini-Card:
 - a. Align the Mini-Card with the connector at a 45-degree angle, and press the Mini-Card down into the securing clips until the card clicks into place.



1	securing clips (2)	2	antenna connectors (2)	3	Mini-Card connector
---	--------------------	---	------------------------	---	---------------------

NOTICE: To avoid damaging the Mini-Card, never place cables under the card.

- b. Connect the antenna cables to the antenna connectors on the Mini-Card by matching the color of the cable to the color of the triangle above the connector. Connect the main antenna cable (white) to the antenna connector with the white triangle. Connect the auxiliary antenna cable (black) to the antenna connector with the black triangle.

 **NOTE:** If your computer has a gray cable, connect it to the connector with the gray triangle, if one is available on your card.



6. Replace the Mini-Card/modem cover.

Hinge Cover

 **CAUTION:** Before you begin any of the procedures in this section, follow the safety instructions in the *Product Information Guide*.

 **NOTICE:** To avoid electrostatic discharge, ground yourself by using a wrist grounding strap or by periodically touching an unpainted metal surface (such as a connector on the back of the computer).

 **NOTICE:** To avoid damaging the system board, you must remove the battery before you begin working inside the computer.

1. Follow the procedures in [Before You Begin](#).

2. Remove the hinge cover:

a. Open the display all the way (180 degrees) so that it lies flat against your work surface.

 **NOTICE:** To avoid damaging the hinge cover, do not lift the cover on both sides simultaneously. Do not use excessive force when removing the cover.

b. Insert a scribe into the indent to lift the hinge cover on the right side.

c. Ease the hinge cover up, moving from right to left, and remove it.

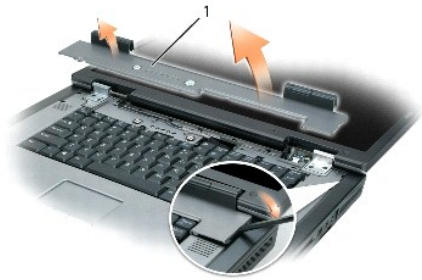



		1	hinge cover		
--	--	---	-------------	--	--

When replacing the hinge cover, first insert the left edge and then press from left to right until the cover snaps into place.

Keyboard

 **CAUTION:** Before you begin any of the procedures in this section, follow the safety instructions in the *Product Information Guide*.

 **NOTICE:** To avoid electrostatic discharge, ground yourself by using a wrist grounding strap or by periodically touching an unpainted metal surface (such as a connector on the back of the computer).

 **NOTICE:** To avoid damaging the system board, you must remove the battery before you begin working inside the computer.

1. Follow the procedures in [Before You Begin](#).

2. Open the display and remove the hinge cover. See [Hinge Cover](#).
3. Remove the keyboard:
 - a. Remove the two screws at the top of the keyboard.

🔗 **NOTICE:** The key caps on the keyboard are fragile, easily dislodged, and time-consuming to replace. Be careful when removing and handling the keyboard.

- b. Lift the keyboard and hold it up and slightly forward to access to the keyboard connector.
- c. To disconnect the keyboard cable from the keyboard connector on the system board, rotate the keyboard connector latch toward the front of the computer.
- d. Slide the keyboard cable out of the keyboard connector on the system board.

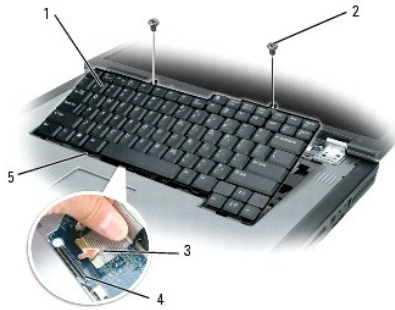

1	keyboard	3	keyboard cable	5	keyboard tabs
2	keyboard screws (2)	4	keyboard connector latch		

🔗 **NOTICE:** To avoid scratching the palm rest when replacing the keyboard, hook the five tabs along the front edge of the keyboard into the palm rest, and then secure the keyboard in place.

Coin-Cell Battery

⚠️ **CAUTION:** Before you begin any of the procedures in this section, follow the safety instructions in the *Product Information Guide*.

🔗 **NOTICE:** To avoid electrostatic discharge, ground yourself by using a wrist grounding strap or by periodically touching an unpainted metal surface (such as a connector on the back of the computer).

🔗 **NOTICE:** To avoid damaging the system board, you must remove the battery before you begin working inside the computer.

1. Follow the procedures in [Before You Begin](#).
2. Remove the hinge cover. See [Hinge Cover](#).
3. Remove the keyboard. See [Keyboard](#).
4. Remove the existing coin-cell battery:
 - a. Pull up on the connector to disconnect the battery cable from the system board.
 - b. Press the release latch on the side of the coin-cell battery compartment, and lift the battery.

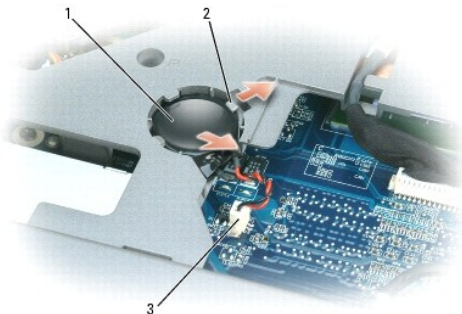

1	coin-cell battery	2	release latch	3	battery cable connector
---	-------------------	---	---------------	---	-------------------------

5. Install the replacement battery:
 - a. Insert the battery at a 30-degree angle under the release latch with the positive side up, and then push the battery into place.
 - b. Connect the battery cable to the connector on the system board.
 6. Replace the keyboard (see [Keyboard](#)).
 7. Replace the hinge cover (see [Hinge Cover](#)).
-

Optical Drive

⚠ CAUTION: Before you begin any of the procedures in this section, follow the safety instructions in the *Product Information Guide*.

1. Follow the procedures in [Before You Begin](#).
2. Turn the computer over.
3. Remove the optical-drive security screw.
4. Insert a scribe into the notch and push it to the side to release the drive from the bay.

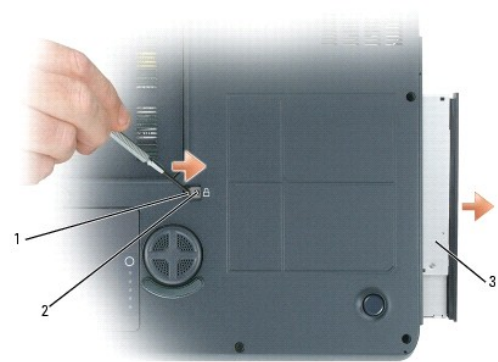

1	notch	2	optical-drive security screw	3	optical drive
---	-------	---	------------------------------	---	---------------

5. Slide the drive out of the bay.

To reinstall the optical drive, slide the drive into the drive bay and snap it into place. Then replace the optical-drive security screw.

Internal Card With Bluetooth® Wireless Technology

⚠ CAUTION: Before you begin any of the procedures in this section, follow the safety instructions in the *Product Information Guide*.

⚡ NOTICE: To avoid electrostatic discharge, ground yourself by using a wrist grounding strap or by periodically touching an unpainted metal surface (such as a connector on the back of the computer).

🔋 NOTICE: To avoid damaging the system board, you must remove the battery before you begin working inside the computer.

If you ordered a card with Bluetooth wireless technology with your computer, it is already installed.

1. Follow the procedures in [Before You Begin](#).
2. Remove the battery. See [Replacing the Battery](#).
3. Remove the cover screw and remove the card cover from the computer.
4. Pull the card out of the compartment so that you can disconnect the card from its cable and remove it from the computer.

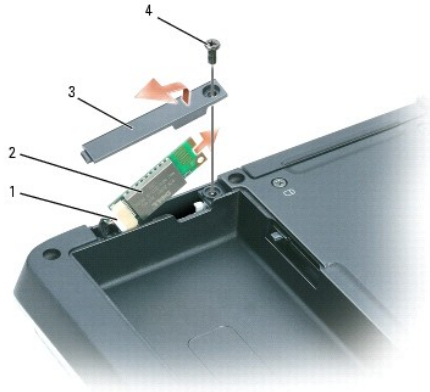

1	cable connector	3	card cover
2	card	4	cover screw

5. To replace the card, connect the card to the cable and then carefully insert it into the compartment.
6. Replace the card cover and tighten the screw.
7. Replace the battery.

[Back to Contents Page](#)

[Back to Contents Page](#)

Dell™ QuickSet

Dell Precision™ M90 User's Guide

 **NOTE:** This feature may not be available on your computer.

Dell™ QuickSet provides you with easy access to configure or view the following types of settings:

- 1 Network connectivity
- 1 Power management
- 1 Display
- 1 System information

Depending on what you want to do in Dell™ QuickSet, you can start it by either *clicking*, *double-clicking*, or *right-clicking* the QuickSet icon,  , in the Microsoft® Windows® taskbar. The taskbar is located in the lower-right corner of your screen.

For more information about QuickSet, right-click the QuickSet icon and select **Help**.

[Back to Contents Page](#)

[Back to Contents Page](#)

Securing Your Computer

Dell Precision™ M90 User's Guide

- [Security Cable Lock](#)
 - [Smart Cards](#)
 - [Installing a Smart Card](#)
 - [Passwords](#)
 - [Trusted Platform Module \(TPM\)](#)
 - [Computer Tracking Software](#)
 - [If Your Computer Is Lost or Stolen](#)
 - [Alert Standard Format \(ASF\)](#)
-

Security Cable Lock

 **NOTE:** Your computer does not ship with a security cable lock.

A security cable lock is a commercially available antitheft device. To use the lock, attach it to the security cable slot on your Dell™ computer. For more information, see the instructions included with the device.

 **NOTICE:** Before you buy an antitheft device, ensure that it will work with the security cable slot on your computer.



Smart Cards

 **NOTE:** For information on how to secure your computer while traveling, see [Traveling With Your Computer](#).

Smart cards are portable credit-card shaped devices with internal integrated circuits. The top surface of the smart card usually contains an embedded processor under the gold contact pad. The combination of the small size and integrated circuits make smart cards valuable tools for security, data storage, and special programs. Using smart cards can improve system security by combining something a user has (the smart card) with something only the user should know (a PIN) to provide more secure user-authentication than passwords alone.

Installing a Smart Card

You can install a smart card in the computer while the computer is running. The computer automatically detects the card.

To install a smart card:

1. Hold the card so that the gold contact pad is facing upward and pointing toward the smart card slot.

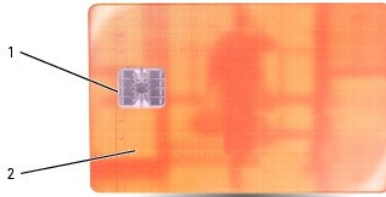

1	gold contact pad	2	smart card (top)		
---	------------------	---	------------------	--	--

- Slide the smart card into the smart card slot until the card is completely seated in its connector. The smart card will protrude approximately 1/2 inch from the slot.

If you encounter too much resistance, do not force the card. Check the card orientation and try again.



1	smart card slot	2	smart card	3	ExpressCard slot
---	-----------------	---	------------	---	------------------

Passwords

About Passwords

NOTE: Passwords are disabled when you receive your computer.

A primary password, an administrator password, and a hard drive password all prevent unauthorized access to your computer in different ways. The following table identifies types and features of passwords available on your computer.

Type of Password	Features
Primary	<ol style="list-style-type: none"> Protects the computer from unauthorized access
Administrator	<ol style="list-style-type: none"> Gives system administrators or service technicians access to computers for repair or reconfiguration Allows you to restrict access to system setup in the same way a primary password restricts access to the computer Can be used instead of the primary password
Hard drive	<ol style="list-style-type: none"> Helps protect the data on your hard drive or external hard drive (if one is being used) from unauthorized access

NOTE: Some hard drives do not support hard drive passwords.

NOTICE: Passwords provide a high level of security for data in your computer or hard drive. However, they are not foolproof. If you require more security, obtain and use additional forms of protection, such as smart cards, data encryption programs, or PC Cards with encryption features.

When using passwords, observe the following guidelines:

- Choose passwords that you can remember, but not ones that are easy to guess. For example, do not use the names of family members or pets for

passwords.

- 1 It is recommended that you do not write down passwords. If you do write it down, however, ensure that the password is stored in a secure place.
- 1 Do not share passwords with other people.
- 1 Ensure that people are not watching you when you type your password(s).

 **NOTICE:** Passwords provide a high level of security for data in your computer or hard drive. However, they are not foolproof. If you require more security, obtain and use additional forms of protection, such as smart cards, data encryption programs, or PC Cards with encryption features.

If you forget any of your passwords, contact Dell (see [Contacting Dell](#)). For your protection, Dell technical support staff will ask you for proof of your identity to ensure that only an authorized person can use the computer.

Using a Primary Password

The primary password allows you to protect the computer from unauthorized access.

When you first start your computer, you must assign a primary password at the prompt.

If you do not enter a password within 2 minutes, the computer returns to its previous operating state.

 **NOTICE:** If you disable the administrator password, the primary password is also disabled.

To add or change passwords, access **User Accounts** from the **Control Panel**.

If you have assigned an administrator password, you can use it instead of the primary password. The computer does not specifically prompt you for the administrator password.

Using an Administrator Password

The administrator password is designed to give system administrators or service technicians access to computers for repair or reconfiguration. The administrators or technicians can assign identical administrator passwords to groups of computers, allowing you to assign a unique primary password.

To set or change administrator passwords, access **User Accounts** from the Control Panel.

When you set an administrator password, the **Configure Setup** option becomes available in system setup. The **Configure Setup** option allows you to restrict access to system setup in the same way that a primary password restricts access to the computer.

The administrator password can be used instead of the primary password. Whenever you are prompted to enter the primary password, you can enter the administrator password.

 **NOTICE:** If you disable the administrator password, the primary password is also disabled.

 **NOTE:** The administrator password provides access to the computer, but it does not provide access to the hard drive when a hard drive password is assigned.

If you forget the primary password and do not have an administrator password assigned, or if you have both a primary and an administrator password assigned but forget them both, contact your system administrator or contact Dell. See [Contacting Dell](#).

Using a Hard Drive Password

The hard drive password helps protect the data on your hard drive from unauthorized access. You can also assign a password for an external hard drive (if one is being used) that can be the same as or different from the password for the primary hard drive.

To assign or change a hard drive password, enter system setup. See [System Setup Program](#).

After assigning a hard drive password, you must enter it each time you turn on the computer and each time you restore the computer to normal operation from standby mode.

If the hard drive password is enabled, you must enter it each time you turn on the computer: A message appears asking for the hard drive password.

To continue, enter your password (with no more than eight characters) and press <Enter>.

If you do not enter a password within 2 minutes, the computer returns to its previous operating state.

If you enter the wrong password, a message tells you that the password is invalid. Press <Enter> to try again.

If you do not enter the correct password in three attempts, the computer tries to start from another bootable device if the **Boot First Device** option in system setup is set to allow start-up from another device. If the **Boot First Device** option is not set to allow the computer to start from another device, the computer returns to the operating state it was in when you turned it on.

If the hard drive password, the external hard-drive password, and the primary password are the same, the computer prompts you only for the primary password. If the hard drive password is different from the primary password, the computer prompts you for both. Two different passwords provide greater security.

 **NOTE:** The administrator password provides access to the computer, but it does not provide access to the hard drive when a hard drive password is assigned.

Trusted Platform Module (TPM)

 **NOTE:** The TPM feature supports encryption only if the operating system supports TPM. For more information, see the TPM software documentation and the help files that came with the software.

TPM is a hardware-based security feature that can be used to create and manage computer-generated encryption keys. When combined with security software, the TPM enhances existing network and computer security by enabling features such as file protection capabilities and protected e-mail. The TPM feature is enabled through a system setup option.

 **NOTICE:** To secure your TPM data and encryption keys, follow the backup procedures documented in the *Broadcom Secure Foundation Getting Started Guide*. In the event of these backups being incomplete, lost, or damaged, Dell will be unable to assist in the recovery of encrypted data.

Enabling the TPM Feature

The TPM software is factory-installed in the C:\Dell\TPM directory. You can also download it from support.dell.com.

1. To install the TPM software, run the **setup.exe** file:

Follow the instructions to install the Broadcom Secure Foundation software.

2. To enable the TPM software:
 - a. **Restart the computer and press <F2> during the Power On Self Test to enter the system setup program.**
 - d. Open the **Security** menu in system setup.
 - e. Select the **TPM Security** menu option and press <Enter>.
 - f. Set the TPM security option to **On**.
 - g. Press <Esc> to exit the setup program.
 - h. If prompted, click **Save/Exit**.
 - i. If the TPM on this computer is being used for the first time, proceed to [step 3](#). If the TPM on this system has been used before, skip step 3 and go to [step 4](#).
3. Activate the TPM setup program:
 - a. Boot your computer to the Microsoft® Windows® operating system.
 - b. Click **Start**→**Programs**→**Broadcom Security Platforms Tools**. Then, click the icon for the **Security Platform Initialization Wizard**.
 - c. Follow the instructions to activate the TPM setup program.

 **NOTE:** You only need to activate the program once.

- d. Once the process is complete, the computer either restarts automatically or prompts you to restart your computer.
4. Physically activate the TPM:
 - a. Restart the computer and press <F2> during the Power On Self Test to enter the system setup program again.
 - b. Open the **Security** menu and select the **TPM Activation** menu option.
 - c. Set the TPM activation state to **Activate**.
 - d. Save the changes and restart your computer.
 5. Initialize the TPM owner and user passwords:
 - a. Boot your computer to the Microsoft Windows operating system.
 - b. Click **Start**→**Programs**→**Broadcom Security Platforms Tools**. Then, click the icon for the **Security Platform Initialization Wizard**.
 - c. Follow the instructions for creating the TPM owner, user passwords, and credentials.

Computer Tracking Software

Computer tracking software may enable you to locate your computer if it is lost or stolen. The software is optional and may be purchased when you order your Dell™ computer, or you can contact your Dell sales representative for information about this security feature.

 **NOTE:** Computer tracking software may not be available in certain countries.

 **NOTE:** If you have computer tracking software and your computer is lost or stolen, you must contact the company that provides the tracking service to report the missing computer.

If Your Computer Is Lost or Stolen

- 1 Call a law enforcement agency to report the lost or stolen computer. Include the Service Tag in your description of the computer. Ask that a case number be assigned and write down the number, along with the name, address, and phone number of the law enforcement agency. If possible, obtain the name of the investigating officer.

 **NOTE:** If you know where the computer was lost or stolen, call a law enforcement agency in that area. If you do not know, call a law enforcement agency where you live.

- 1 If the computer belongs to a company, notify the security office of the company.
- 1 Contact Dell customer service to report the missing computer. Provide the computer Service Tag, the case number, and the name, address, and phone number of the law enforcement agency to which you reported the missing computer. If possible, give the name of the investigating officer.

The Dell customer service representative will log your report under the computer Service Tag and record the computer as missing or stolen. If someone calls Dell for technical assistance and gives your Service Tag, the computer is identified automatically as missing or stolen. The representative will attempt to get the phone number and address of the caller. Dell will then contact the law enforcement agency to which you reported of the missing computer.

Alert Standard Format (ASF)

Alert Standard Format (ASF) is a Distributed Management Task Force (DMTF) management standard that specifies "pre-operating system" or "operating system absent" alerting techniques. The standard is designed to generate an alert on potential security and fault conditions when the operating system is in a sleep state or the system is turned off. ASF is designed to supersede previous operating system-absent alerting technologies.

Your computer supports the following ASF alerts and remote capabilities:

Alert	Description
Chassis Intrusion - Physical Security Violation/Chassis Intrusion - Physical Security Violation Event Cleared	The docking device has been opened and the PCI slot has been compromised.
Failure to Boot to BIOS	The BIOS did not complete loading upon initiation.
System Password Violation	The system password is invalid (alert occurs after three failed attempts).
Entity Presence	Periodic heartbeats have been transmitted to verify system presence.

For more information about Dell's ASF implementation, see *ASF for Dell Portable Computers* and the *ASF Administrator's Guide for Dell Portable Computers*, which are available on the Dell Support website at support.dell.com.

[Back to Contents Page](#)

[Back to Contents Page](#)

System Setup Program

Dell Precision™ M90 User's Guide

- [Overview](#)
 - [System Setup Screens](#)
 - [Commonly Used Options](#)
-

Overview

 **NOTE:** Your operating system may automatically configure most of the options available in system setup, thus overriding options that you set through system setup. (An exception is the **External Hot Key** option, which you can disable or enable only through system setup.) For more information on configuring features for your operating system, access the Help and Support Center (see [Windows Help and Support Center](#)).

You can use system setup as follows:

- 1 To set or change user-selectable features—for example, your computer password
- 1 To verify information about the computer's current configuration, such as the amount of system memory

After you set up the computer, run system setup to familiarize yourself with your system configuration information and optional settings. You may want to write down the information for future reference.

The system setup screens display the current setup information and settings for your computer, such as:

- 1 System configuration
- 1 Boot order
- 1 Boot (start-up) configuration and docking-device configuration settings
- 1 Basic device-configuration settings
- 1 System security and hard-drive password settings

 **NOTICE:** Unless you are an expert computer user or are directed to do so by Dell technical support, do not change the system setup settings. Certain changes might make your computer work incorrectly.

Viewing the System Setup Screens

1. Turn on (or restart) your computer.
 2. When the DELL™ logo appears, press <F2> immediately. If you wait too long and the Windows logo appears, continue to wait until you see the Windows desktop. Then shut down your computer and try again.
-

System Setup Screens

In the system setup program, primary categories of settings are listed on the left. To view the types of settings in a category, highlight the category and press <Enter>. When you highlight a setting type, the right side of the screen displays the value for that setting type. You can change settings that appear as white text on the screen. Values that you cannot change (because they are determined by the computer) appear less bright.

System-setup key functions are listed across the bottom of the screen.

Commonly Used Options

Certain options require that you reboot the computer for new settings to take effect.

Changing the Boot Sequence

The *boot sequence* tells the computer where to look to find the software needed to start the operating system. You can control the boot sequence and enable/disable devices using the **Boot Sequence** page, which is located in the **System** category.

 **NOTE:** To change the boot sequence on a one-time-only basis, see [Performing a One-Time Boot](#).

The **Boot Sequence** page displays a general list of the bootable devices that may be installed in your computer, including but not limited to the following:

- 1 Diskette Drive

- 1 **Modular bay HDD**
- 1 **Internal HDD**
- 1 **CD/DVD/CD-RW drive**

 **NOTE:** You can only boot (start up) your computer from a CD, CD-RW, or DVD drive installed as a fixed drive. You cannot boot from one of these modules if it is installed in the module bay.

During the boot routine, the computer starts at the top of the list and scans each enabled device for the operating system start-up files. When the computer finds the files, it stops searching and starts the operating system.

To control the boot devices, select (highlight) a device by pressing the down-arrow or up-arrow key, and then enable or disable the device or change its order in the list.

- 1 To enable or disable a device, highlight the item and press the space bar. Enabled items appear as white and display a small triangle to the left; disabled items appear blue or dimmed without a triangle.
- 1 To reorder a device in the list, highlight the device and then press <u> or <d> (not case-sensitive) to move the highlighted device up or down.

Boot sequence changes take effect as soon as you save the changes and exit system setup.

Performing a One-Time Boot

You can set a one-time-only boot sequence without entering system setup. (You can also use this procedure to boot the Dell Diagnostics on the diagnostics utility partition on your hard drive.)

1. Shut down the computer through the **Start** menu.
2. If the computer is connected to a docking device (docked), undock it. See the documentation that came with your docking device for instructions.
3. Connect the computer to an electrical outlet.
4. Turn on the computer. When the DELL logo appears, press <F12> immediately. If you wait too long and the Windows logo appears, continue to wait until you see the Windows desktop. Then shut down your computer and try again.
5. When the boot device list appears, highlight the device from which you want to boot and press <Enter>.

The computer boots to the selected device.

The next time you reboot the computer, the previous boot sequence is restored.

[Back to Contents Page](#)

[Back to Contents Page](#)

Reinstalling Software

Dell Precision™ M90 User's Guide

- [Drivers](#)
 - [Software and Hardware Incompatibilities](#)
 - [Restoring Your Operating System](#)
-

Drivers

What Is a Driver?

A driver is a program that controls a device such as a printer, mouse, or keyboard. All devices require a driver program.

A driver acts like a translator between the device and any other programs that use the device. Each device has its own set of specialized commands that only its driver recognizes.

Dell ships your computer to you with required drivers already installed—no further installation or configuration is needed.

 **NOTICE:** The *Drivers and Utilities* CD may contain drivers for operating systems that are not on your computer. Ensure that you are installing software appropriate for your operating system.

Many drivers, such as the keyboard driver, come with your Microsoft® Windows® operating system. You may need to install drivers if you:

- 1 Upgrade your operating system.
- 1 Reinstall your operating system.
- 1 Connect or install a new device.

Identifying Drivers

If you experience a problem with any device, identify whether the driver is the source of your problem and, if necessary, update the driver.

Windows XP

1. Click the **Start** button and click **Control Panel**.
2. Under **Pick a Category**, click **Performance and Maintenance**.
3. Click **System**.
4. In the **System Properties** window, click the **Hardware** tab.
5. Click **Device Manager**.
6. Scroll down the list to see if any device has an exclamation point (a yellow circle with a [!]) on the device icon.

If an exclamation point is next to the device name, you may need to reinstall the driver or install a new driver. See [Reinstalling Drivers and Utilities](#).

Reinstalling Drivers and Utilities

 **NOTICE:** The Dell Support website at support.dell.com and your *Drivers and Utilities* CD provide approved drivers for Dell™ computers. If you install drivers obtained from other sources, your computer might not work correctly.

Using Windows XP Device Driver Rollback

If a problem occurs on your computer after you install or update a driver, use Windows XP Device Driver Rollback to replace the driver with the previously installed version.

1. Click the **Start** button and click **Control Panel**.

2. Under **Pick a Category**, click **Performance and Maintenance**.
3. Click **System**.
4. In the **System Properties** window, click the **Hardware** tab.
5. Click **Device Manager**.
6. Right-click the device for which the new driver was installed and click **Properties**.
7. Click the **Drivers** tab.
8. Click **Roll Back Driver**.

If Device Driver Rollback does not resolve the problem, then use System Restore to return your computer to the operating state that existed before you installed the new driver. See [Enabling System Restore](#).

Using the Drivers and Utilities CD

If using Device Driver Rollback or System Restore does not resolve the problem, then reinstall the driver from the *Drivers and Utilities* CD (also known as the Resource CD). See [Enabling System Restore](#).

1. Save and close any open files, and exit any open programs.
2. Insert the *Drivers and Utilities* CD.

In most cases, the CD starts running automatically. If it does not, start Windows Explorer, click your CD drive directory to display the CD contents, and then double-click the **autorcd.exe** file. The first time that you run the CD, it might prompt you to install setup files. Click **OK**, and follow the instructions on the screen to continue.

3. From the **Language** drop-down menu in the toolbar, select your preferred language for the driver or utility (if available). A welcome screen appears.
4. Click **Next**.

The CD automatically scans your hardware to detect drivers and utilities used by your computer.

5. After the CD completes the hardware scan, you can also detect other drivers and utilities. Under **Search Criteria**, select the appropriate categories from the **System Model**, **Operating System**, and **Topic** drop-down menus.

A link or links appear(s) for the specific drivers and utilities used by your computer.

6. Click the link of a specific driver or utility to display information about the driver or utility that you want to install.
7. Click the **Install** button (if present) to begin installing the driver or utility. At the welcome screen, follow the screen prompts to complete the installation.

If no **Install** button is present, automatic installation is not an option. For installation instructions, either see the appropriate instructions in the following subsections, or click **Extract**, follow the extracting instructions, and then read the readme file.

If instructed to navigate to the driver files, click the CD directory on the driver information window to display the files associated with that driver.

Manually Reinstalling Drivers



NOTE: If you are reinstalling an infrared sensor driver, you must first enable the infrared sensor in system setup before continuing with the driver installation. See [System Setup Program](#).

1. After extracting the driver files to your hard drive as described in the previous section, click the **Start** button and right-click **My Computer**.
2. Click **Properties**.
3. Click the **Hardware** tab and click **Device Manager**.
4. Double-click the type of device for which you are installing the driver (for example, **Modems** or **Infrared devices**).
5. Double-click the name of the device for which you are installing the driver.
6. Click the **Driver** tab and click **Update Driver**.
7. Click **Install from a list or specific location (Advanced)** and click **Next**.

8. Click **Browse** and browse to the location to which you previously copied the driver files.
 9. When the name of the appropriate driver appears, click **Next**.
 10. Click **Finish** and restart your computer.
-

Software and Hardware Incompatibilities

If a device is either not detected during the operating system setup or is detected but incorrectly configured, you can use the Hardware Troubleshooter to resolve the incompatibility.

To start the Hardware Troubleshooter:

1. Click the **Start** button and click **Help and Support**.
 2. Type `hardware troubleshooter` in the **Search** field and click the arrow to start the search.
 3. Click **Hardware Troubleshooter** in the **Search Results** list.
 4. In the **Hardware Troubleshooter** list, click **I need to resolve a hardware conflict on my computer**, and click **Next**.
-

Restoring Your Operating System

You can restore your operating system in the following ways:

1. Microsoft® Windows® XP System Restore returns your computer to an earlier operating state without affecting data files. Use System Restore as the first solution for restoring your operating system and preserving data files.
1. If you received an *Operating System* CD with your computer, you can use it to restore your operating system. However, using the *Operating System* CD also deletes all data on the hard drive. Use the CD *only* if System Restore did not resolve your operating system problem.

Using Microsoft Windows XP System Restore

The Microsoft Windows XP operating system provides System Restore to allow you to return your computer to an earlier operating state (without affecting data files) if changes to the hardware, software, or other system settings have left the computer in an undesirable operating state. See the Windows Help and Support Center for information on using System Restore.

 **NOTICE:** Make regular backups of your data files. System Restore does not monitor your data files or recover them.

 **NOTE:** The procedures in this document were written for the Windows default view, so they may not apply if you set your Dell™ computer to the Windows Classic view.

Creating a Restore Point

1. Click the **Start** button and click **Help and Support**.
2. Click the task for **System Restore**.
3. Follow the instructions on the screen.

Restoring the Computer to an Earlier Operating State

 **NOTICE:** Before you restore the computer to an earlier operating state, save and close any open files and exit any open programs. Do not alter, open, or delete any files or programs until the system restoration is complete.

1. Click the **Start** button, point to **All Programs**→ **Accessories**→ **System Tools**, and then click **System Restore**.
2. Ensure that **Restore my computer to an earlier time** is selected and click **Next**.
3. Click a calendar date to which you want to restore your computer.

The **Select a Restore Point** screen provides a calendar that allows you to see and select restore points. All calendar dates with available restore points appear in boldface type.

4. Select a restore point and click **Next**.

If a calendar date has only one restore point, then that restore point is automatically selected. If two or more restore points are available, click the restore point that you prefer.

5. Click **Next**.

The **Restoration Complete** screen appears after System Restore finishes collecting data and then the computer restarts.

6. After the computer restarts, click **OK**.

To change the restore point, you can either repeat the steps using a different restore point, or you can undo the restoration.

Undoing the Last System Restore

 **NOTICE:** Before you undo the last system restore, save and close all open files and exit any open programs. Do not alter, open, or delete any files or programs until the system restoration is complete.

1. Click the **Start** button, point to **All Programs**→ **Accessories**→ **System Tools**, and then click **System Restore**.
2. Click **Undo my last restoration** and click **Next**.

Enabling System Restore

If you reinstall Windows XP with less than 200 MB of free hard-disk space available, System Restore is automatically disabled. To see if System Restore is enabled:

1. Click the **Start** button and click **Control Panel**.
2. Click **Performance and Maintenance**.
3. Click **System**.
4. Click the **System Restore** tab.
5. Ensure that **Turn off System Restore** is unchecked.

Using the Operating System CD

Before You Begin

If you are considering reinstalling the Windows XP operating system to correct a problem with a newly installed driver, first try using Windows XP Device Driver Rollback. See [Using Windows XP Device Driver Rollback](#). If Device Driver Rollback does not resolve the problem, then use [System Restore](#) to return your operating system to the operating state it was in before you installed the new device driver. See [Using Microsoft Windows XP System Restore](#).

 To reinstall Windows XP, you need the following items:

1. Dell™ *Operating System* CD
1. Dell *Drivers and Utilities* CD

 **NOTE:** The *Drivers and Utilities* CD contains drivers that were installed during assembly of the computer. Use the *Drivers and Utilities* CD to load any required drivers, including the drivers required if your computer has a RAID controller.

Reinstalling Windows XP

The reinstallation process can take 1 to 2 hours to complete. After you reinstall the operating system, you must also reinstall the device drivers, virus protection program, and other software.

 **NOTICE:** The *Operating System* CD provides options for reinstalling Windows XP. The options can overwrite files and possibly affect programs installed on your hard drive. Therefore, do not reinstall Windows XP unless a Dell technical support representative instructs you to do so.

1. Save and close any open files and exit any open programs.
2. Insert the *Operating System* CD. Click **Exit** if the **Install Windows XP** message appears.

3. Restart the computer.

4. Press <F2> immediately after the DELL™ logo appears.

If the operating system logo appears, wait until you see the Windows desktop, and then shut down the computer and try again.

5. Follow the instructions on the screen to complete the installation.

[Back to Contents Page](#)

Specifications

Dell Precision™ M90 User's Guide

 **NOTE:** Your computer comes in different configurations. To determine the configuration of your computer, see [Determining Your Computer's Configuration](#).

Processor	
Processor type	Intel® Core™ Solo processor Intel® Core™ Duo processor
L1 cache	64 KB
L2 cache	2 MB
External bus frequency (front side bus)	533 MHz or 667 MHz

System Information	
System chip set	Mobile Intel 945PM Express
Data bus width	64 bits
DRAM bus width	dual channel bus
Processor address bus width	32 bits
Flash EPROM	1 MB
PCI bus (PCI-Express used for video controllers)	32 bits x16

ExpressCard	
NOTE: The ExpressCard slot is designed only for ExpressCards. It does NOT support PC Cards (PCMCIA cards).	
ExpressCard connector	one ExpressCard slot (54 mm) 1.5 V and 3.3 V
Cards supported	ExpressCard/34 (34 mm) and ExpressCard/54 (54 mm)
ExpressCard connector size	26 pins

Memory	
Memory module connector	two user-accessible SODIMM connectors
Memory module capacities	256 MB, 512 MB, 1 GB, and 2 GB
Memory type	1.8 V SODIMM DDR-II supports DDR-II up to 667 MHz
Minimum memory	512 MB (via 2 x 256 MB SoDimms)
Maximum memory	4 GB (via 2 x 2 GB SoDimms)
NOTE: In order to obtain dual-channel bandwidth capability, both memory slots must be populated with the same size memory modules.	

5-in-1 media memory card reader	
5-in-1 media memory card controller	Ricoh R5C832
5-in-1 media memory card connector	5-in-1 combo card connector
Cards supported	MS MS Pro SD/SDIO MMC xD CD Type I/II & IBM Microdrive through ExpressCard

	adapter
--	---------

Ports and Connectors	
Audio	microphone-in connector, stereo headphones/speakers connector
IEEE 1394a	4-pin mini, nonpowered connector
Modem	RJ-11 port
Network adapter	RJ-45 port
S-video TV-out	7-pin mini-DIN connector (optional S-video to composite video adapter cable; optional S-video to component video adapter cable)
USB	six 4-pin USB 2.0-compliant connectors
Video	15-pin connector
DVI-D (Digital Video Interface)	24-pin connector

Communications	
Modem:	
Type	V.92 56K MDC
Controller	softmodem
Interface	internal HDA (High Definition Audio) bus
Network adapter	10/100/1000 Ethernet LAN on system board
Wireless	internal PCI-e Mini-Card WLAN support; internal card with Bluetooth® wireless technology

Video	
NOTE: Your computer comes in different configurations with different video controller cards. To determine the configuration of your computer, see Determining Your Computer's Configuration .	
video type	256-bit memory interface
data bus	PCI Express
video controller	NVIDIA Quadro FX 1500M 256MB NVIDIA Quadro FX 2500M 512MB
video memory	256 MB or 512 MB
LCD interface	LVDS
TV support	NTSC or PAL in S-video and composite modes

Audio	
Audio type	High Definition Audio (HDA) codec
Stereo conversion	24-bit (analog-to-digital and digital-to-analog)
Interfaces:	
Internal	HDA bus
External	microphone-in connector, stereo headphones/speakers connector
Speaker	stereo 2-W main speakers and 5-W subwoofer with bass reflex port
Internal speaker amplifier	2 W per channel main amplifier and 5-W Class D subwoofer amplifier
Volume controls	keyboard shortcuts, program menus, media control buttons
Audio controller	Sigmatel STAC92XX codec

Display	
Type (active-matrix TFT)	WXGA+; WUXGA
Dimensions:	
Height	245.0 mm (9.64 inches)
Width	383.0 mm (15 inches)
Diagonal	431.8 mm (17 inches)

Maximum resolutions:	
WXGA+	1440 x 900 at 16.7 million colors
WUXGA	1920 x 1200 at 16.7 million colors
Refresh rate	60 Hz
Operating angle	0° (closed) to 180°
Viewing angle (typical):	
Horizontal	±40° (WXGA)
	±60° (WUXGA)
Vertical	+15°/-30° (WXGA)
	±45° (WUXGA)
Pixel pitch:	
WXGA+	0.255 mm (17-inch display)
WUXGA	0.191 mm (17-inch display)
Power consumption (panel with backlight) (typical):	7.54 W
Controls	brightness can be controlled through keyboard shortcuts

Keyboard	
Number of keys	87 (U.S. and Canada); 88 (Europe); 91 (Japan)
Layout	QWERTY/AZERTY/Kanji

Touch Pad	
X/Y position resolution (graphics table mode)	240 cpi
Size:	
Width	73.0-mm (2.88-inch) sensor-active area
Height	42.9-mm (1.69-inch) rectangle

Battery	
Type	9-cell "smart" lithium ion
Dimensions:	
Depth	88.5 mm (3.48 inches)
Height	21.5 mm (0.83 inch)
Width	139.0 mm (5.47 inches)
Weight	0.40 kg (0.88 lb) (9 cell)
Voltage	10.8 VDC
Charge time (approximate):	
Computer off	2 hours (at 100% in 2 hours) 1 hour (at 80% in 1 hour)
Operating time	Battery operating time varies depending on operating conditions and can be significantly reduced under certain power-intensive conditions. See Power Problems . See Using a Battery for more information on battery life.
Life span (approximate)	300 discharge/charge cycles
Temperature range:	
Operating	0° to 35°C (32° to 95°F)
Storage	-40° to 65°C (-40° to 149°F)

AC Adapter	
<p>NOTE: For optimum system performance, always use a 130-W adapter. Using less powerful AC adapters may cause you to receive a warning message and may also cause your computer to experience a degradation in performance.</p>	

Input voltage	90–264 VAC
Input current (maximum)	2.5 A
Input frequency	47–63 Hz
Output current	7.7 A (maximum at 4-second pulse); 6.67 A (continuous)
Output power	130 W
Rated output voltage	19.5 VDC
Dimensions:	
Height	36 mm (1.35 inches)
Width	65 mm (2.39 inches)
Depth	169.5 mm (6.04 inches)
Weight (with cables)	0.76 kg (1.68 lb)
Temperature range:	
Operating	0° to 35°C (32° to 95°F)
Storage	–40° to 65°C (–40° to 149°F)



Physical	
Height	41.5 mm (1.6 inches)
Width	394 mm (15.5 inches)
Depth	288 mm (11.3 inches)
Weight (with 9-cell battery):	
With optical drive	3.96 kg (8.7 lb)

Environmental	
Temperature range:	
Operating	0° to 35°C (32° to 95°F)
Storage	–40° to 65°C (–40° to 149°F)
Relative humidity:	
Operating	10% to 90% (noncondensing)
Storage	5% to 95% (noncondensing)
Maximum vibration (using a random-vibration spectrum that simulates user environment):	
Operating	0.66 GRMS
Storage	1.3 GRMS
Maximum shock (measured with a 2-ms half-sine pulse):	
Operating	143 G
Storage	163 G
Altitude (maximum):	
Operating	–15.2 to 3048 m (–50 to 10,000 ft)
Storage	–15.2 to 10,668 m (–50 to 35,000 ft)

[Back to Contents Page](#)

[Back to Contents Page](#)

Dell Precision™ Mobile
Workstation M90 User's Guide

-  **NOTE:** A NOTE indicates important information that helps you make better use of your computer.
-  **NOTICE:** A NOTICE indicates either potential damage to hardware or loss of data and tells you how to avoid the problem.
-  **CAUTION:** A CAUTION indicates a potential for property damage, personal injury, or death.

For a complete list of abbreviations and acronyms, see [Glossary](#).

If you purchased a Dell™ n Series computer, any references in this document to Microsoft® Windows® operating systems are not applicable.

Information in this document is subject to change without notice.
© 2006-2009 Dell Inc. All rights reserved.

Reproduction in any manner whatsoever without the written permission of Dell Inc. is strictly forbidden.

Trademarks used in this text: *Dell*, the *DELL* logo, *Inspiron*, *Dell Precision*, *Dimension*, *OptiPlex*, *Latitude*, *PowerEdge*, *PowerConnect*, *PowerVault*, *PowerApp*, *Dell TravelLite*, *ExpressCharge*, *Undock & Go*, and *Strike Zone* are trademarks of Dell Inc.; *Intel* is a registered trademark and *Core* is a trademark of Intel Corporation; *Microsoft*, *Outlook*, and *Windows* are registered trademarks of Microsoft Corporation; *Bluetooth* is a registered trademark owned by Bluetooth SIG, Inc. and is used by Dell under license; *EMC* is a registered trademark of EMC Corporation; *ENERGY STAR* is a registered trademark of the U.S. Environmental Protection Agency.

Other trademarks and trade names may be used in this document to refer to either the entities claiming the marks and names or their products. Dell Inc. disclaims any proprietary interest in trademarks and trade names other than its own.

Model PP05XA

September 2009 P/N ND244 Rev. A01

[Back to Contents Page](#)

[Back to Contents Page](#)

Transferring Information to a New Computer

Dell Precision™ M90 User's Guide

The Microsoft® Windows® XP operating system provides a **Files and Settings Transfer Wizard** to move data from a source computer to a new computer. You can transfer data, such as:

- 1 E-mail messages
- 1 Toolbar settings
- 1 Window sizes
- 1 Internet bookmarks

You can transfer the data to the new computer over a network connection, or you can store it on a removable media, such as a writable CD, for transfer to the new computer.

For transferring information to a new computer, you must run the Files and Settings Transfer Wizard. You can use the optional *Operating System* CD for this process or you can create a wizard disk with the Files and Settings Transfer Wizard.

Running the Files and Settings Transfer Wizard With the Operating System CD

 **NOTE:** This procedure requires the *Operating System* CD. This CD is optional and may not be included with all computers.

To prepare the new computer for the file transfer, open the **Files and Settings Transfer Wizard**:

1. Click **Start**→ **All Programs**→ **Accessories**→ **System Tools**→ **Files and Settings Transfer Wizard**.
2. When the **Files and Settings Transfer Wizard** welcome screen appears, click **Next**.
3. On the **Which computer is this?** screen, click **New Computer** and click **Next**.
4. On the **Do you have a Windows XP CD?** screen, click **I will use the wizard from the Windows XP CD** and click **Next**.
5. When the **Now go to your old computer** screen appears, go to your old or source computer. Do *not* click **Next** at this time.

To copy data from the old computer:

1. On the old computer, insert the Windows XP *Operating System* CD.
2. On the **Welcome to Microsoft Windows XP** screen, click **Perform additional tasks**.
3. Under **What do you want to do?**, click **Transfer files and settings**.
4. On the **Files and Settings Transfer Wizard** welcome screen, click **Next**.
5. On the **Which computer is this?** screen, click **Old Computer** and click **Next**.
6. On the **Select a transfer method** screen, click the transfer method you prefer.
7. On the **What do you want to transfer?** screen, select the items you want to transfer and click **Next**.

After the information has been copied, the **Completing the Collection Phase** screen appears.

8. Click **Finish**.

To transfer data to the new computer:

1. On the **Now go to your old computer** screen on the new computer, click **Next**.
2. On the **Where are the files and settings?** screen, select the method you chose for transferring your settings and files and click **Next**.
The wizard reads the collected files and settings and applies them to your new computer.
When all of the settings and files have been applied, the **Finished** screen appears.
3. Click **Finished** and restart the new computer.

Running the Files and Settings Transfer Wizard Without the Operating System CD

To run the Files and Settings Transfer Wizard without the *Operating System* CD, you must create a wizard disk that will allow you to create a backup image file to removable media.

To create a wizard disk, use your new computer with Windows XP and perform the following steps:

1. Click **Start**→ **All Programs**→ **Accessories**→ **System Tools**→ **Files and Settings Transfer Wizard**.
2. When the **Files and Settings Transfer Wizard** welcome screen appears, click **Next**.
3. On the **Which computer is this?** screen, click **New Computer** and click **Next**.
4. On the **Do you have a Windows XP CD?** screen, click **I want to create a Wizard Disk in the following drive:** and click **Next**.
5. Insert the removable media, such as a writable CD, and click **OK**.
6. When the disk creation completes and the **Now go to your old computer** message appears, *do not* click **Next**.
7. Go to the old computer.

To copy data from the old computer:

1. On the old computer, insert the wizard disk.
2. Click the **Start** button and click **Run**.
3. In the **Open** field on the **Run** window, browse to the path for **fastwiz** (on the appropriate removable media) and click **OK**.
4. On the **Files and Settings Transfer Wizard** welcome screen, click **Next**.
5. On the **Which computer is this?** screen, click **Old Computer** and click **Next**.
6. On the **Select a transfer method** screen, click the transfer method you prefer.
7. On the **What do you want to transfer?** screen, select the items you want to transfer and click **Next**.

After the information has been copied, the **Completing the Collection Phase** screen appears.

8. Click **Finish**.

To transfer data to the new computer:

1. On the **Now go to your old computer** screen on the new computer, click **Next**.
2. On the **Where are the files and settings?** screen, select the method you chose for transferring your settings and files and click **Next**. Follow the instructions on the screen.

The wizard reads the collected files and settings and applies them to your new computer.

When all of the settings and files have been applied, the **Finished** screen appears.

3. Click **Finished** and restart the new computer.

 **NOTE:** For more information about this procedure, search support.dell.com for document #PA1089586 (*How Do I Transfer Files From My Old Computer to My New Dell™ Computer Using the Microsoft® Windows® XP Operating System CD?*).

 **NOTE:** Access to the Dell™ Knowledge Base document may not be available in some countries.

[Back to Contents Page](#)

Traveling With Your Computer

Dell Precision™ M90 User's Guide

- [Identifying Your Computer](#)
 - [Packing the Computer](#)
 - [Travel Tips](#)
-

Identifying Your Computer

- 1 Attach a name tag or business card to the computer.
 - 1 Write down your Service Tag and store it in a safe place away from the computer or carrying case. Use the Service Tag if you need to report a loss or theft to law enforcement officials and to Dell.
 - 1 Create a file on the Microsoft® Windows® desktop called **if_found**. Place information such as your name, address, and phone number in this file.
 - 1 Contact your credit card company and ask if it offers coded identification tags.
-

Packing the Computer

- 1 Remove any external devices attached to the computer and store them in a safe place. Remove any cables attached to installed cards, and remove any extended cards. See [Using Cards](#).
- 1 To make the computer as light as possible, replace any devices installed in the module bay with the Dell TravelLite™ module.
- 1 Fully charge the main battery and any spare batteries that you plan to carry with you.
- 1 Shut down the computer.
- 1 Disconnect the AC adapter.

➔ **NOTICE:** When the display is closed, extraneous items on the keyboard or palm rest could damage the display.

- 1 Remove any extraneous items, such as paper clips, pens, and paper, from the keyboard and palm rest and close the display.
- 1 Use the optional Dell™ carrying case to pack the computer and its accessories together safely.
- 1 Avoid packing the computer with items such as shaving cream, colognes, perfumes, or food.

➔ **NOTICE:** If the computer has been exposed to extreme temperatures, allow it to acclimate to room temperature for 1 hour before turning it on.

- 1 Protect the computer, the batteries, and the hard drive from hazards such as extreme temperatures and overexposure to sunlight, dirt, dust, or liquids.
 - 1 Pack the computer so that it does not slide around in the trunk of your car or in an overhead storage compartment.
-

Travel Tips

➔ **NOTICE:** Do not move the computer while using the optical drive to prevent loss of data.

➔ **NOTICE:** Do not check the computer as baggage.

- 1 Consider disabling wireless activity on your computer to maximize battery operating time. To disable wireless activity, press <Fn><F2>.
- 1 Consider changing your power management options to maximize battery operating time. See [Conserving Battery Power](#).
- 1 If you are traveling internationally, carry proof of ownership—or of your right to use the computer if it is company-owned—to speed your passage through customs. Investigate the customs regulations of the countries you plan to visit, and consider acquiring an international carnet (also known as a *merchandise passport*) from your government.
- 1 Find out what type of electrical outlets are used in the countries you will visit, and have appropriate power adapters.
- 1 Check with your credit card company for information about the kinds of emergency travel assistance it offers to users of portable computers.

Traveling by Air

➔ **NOTICE:** Do not walk the computer through a metal detector. Send the computer through an X-ray machine or have it hand-inspected.

- 1 Ensure that you have a charged battery available in case you are asked to turn on the computer.
- 1 Prior to entering the airplane, verify that using a computer is permitted. Some airlines forbid the use of electronic devices during flight. All airlines forbid

the use of electronic devices during takeoff and landing.

[Back to Contents Page](#)

[Back to Contents Page](#)

Troubleshooting

Dell Precision™ M90 User's Guide

Dell Technical Update Service	Lockups and Software Problems
Dell Diagnostics	Memory Problems
Dell Support Utility	Network Problems
Drive Problems	Power Problems
E-Mail, Modem, and Internet Problems	Printer Problems
Error Messages	Scanner Problems
ExpressCard Problems	Sound and Speaker Problems
IEEE 1394 Device Problems	Touch Pad or Mouse Problems
Keyboard Problems	Video and Display Problems

Dell Technical Update Service

The Dell Technical Update service provides proactive e-mail notification of software and hardware updates for your computer. The service is free and can be customized for content, format, and how frequently you receive notifications.

To enroll for the Dell Technical Update service, go to support.dell.com/technicalupdate.



Dell Diagnostics

 **CAUTION:** Before you begin any of the procedures in this section, follow the safety instructions in the *Product Information Guide*.

When to Use the Dell Diagnostics

If you experience a problem with your computer, perform the checks in [Lockups and Software Problems](#) and run the Dell Diagnostics before you contact Dell for technical assistance.

It is recommended that you print these procedures before you begin.

-  **NOTICE:** The Dell Diagnostics works only on Dell computers.
-  **NOTE:** The *Drivers and Utilities* CD is optional and may not ship with your computer.

Start the Dell Diagnostics from either your hard drive or from the *Drivers and Utilities* CD (also known as the *ResourceCD*).

Starting the Dell Diagnostics From Your Hard Drive

The Dell Diagnostics is located on a hidden diagnostic utility partition on your hard drive.

 **NOTE:** If your computer cannot display a screen image, contact Dell. See [Getting Help](#).

1. Shut down the computer.
2. If the computer is connected to a docking device (docked), undock it. See the documentation that came with your docking device for instructions.
3. Connect the computer to an electrical outlet.
4. Diagnostics can be invoked one of two ways:
 - a. Turn on the computer. When the DELL™ logo appears, press <F12> immediately. Select **Diagnostics** from the boot menu and press <Enter>.

 **NOTE:** If you wait too long and the operating system logo appears, continue to wait until you see the Microsoft® Windows® desktop. Then shut down your computer and try again.

- b. Press and hold the <Fn> key while powering the system on.

 **NOTE:** If you see a message stating that no diagnostics utility partition has been found, run the Dell Diagnostics from the *Drivers and Utilities* CD.

The computer runs the Pre-boot System Assessment, a series of initial tests of your system board, keyboard, hard drive, and display.

- 1 During the assessment, answer any questions that appear.
- 1 If a failure is detected, the computer stops and beeps. To stop the assessment and restart the computer, press <n>; to continue to the next test, press <y>; to retest the component that failed, press <r>.
- 1 If failures are detected during the Pre-boot System Assessment, write down the error code(s) and contact Dell. See [Contacting Dell](#).

If the Pre-boot System Assessment completes successfully, you receive the message *Booting Dell Diagnostic Utility Partition*. Press any key to continue.

5. Press any key to start the Dell Diagnostics from the diagnostics utility partition on your hard drive.

Starting the Dell Diagnostics From the Drivers and Utilities CD

1. Insert the *Drivers and Utilities* CD.

2. Shut down and restart the computer.

When the DELL logo appears, press <F12> immediately.

If you wait too long and the Windows logo appears, continue to wait until you see the Windows desktop. Then shut down your computer and try again.

 **NOTE:** The next steps change the boot sequence for one time only. On the next start-up, the computer boots according to the devices specified in the system setup program.

3. When the boot device list appears, highlight **CD/DVD/CD-RW Drive** and press <Enter>.
4. Select the **Boot from CD-ROM** option from the menu that appears and press <Enter>.
5. Type 1 to start the *ResourceCD* menu and press <Enter> to proceed.
6. Select **Run the 32 Bit Dell Diagnostics** from the numbered list. If multiple versions are listed, select the version appropriate for your computer.
7. When the Dell Diagnostics **Main Menu** appears, select the test you want to run.

Dell Diagnostics Main Menu

1. After the Dell Diagnostics loads and the **Main Menu** screen appears, click the button for the option you want.

Option	Function
Express Test	Performs a quick test of devices. This test typically takes 10 to 20 minutes and requires no interaction on your part. Run Express Test first to increase the possibility of tracing the problem quickly.
Extended Test	Performs a thorough check of devices. This test typically takes 1 hour or more and requires you to answer questions periodically.
Custom Test	Tests a specific device. You can customize the tests you want to run.
Symptom Tree	Lists the most common symptoms encountered and allows you to select a test based on the symptom of the problem you are having.

2. If a problem is encountered during a test, a message appears with an error code and a description of the problem. Write down the error code and problem description and follow the instructions on the screen.

If you cannot resolve the error condition, contact Dell. See [Contacting Dell](#).

 **NOTE:** The Service Tag for your computer is located at the top of each test screen. If you contact Dell, technical support will ask for your Service Tag.

3. If you run a test from the **Custom Test** or **Symptom Tree** option, click the applicable tab described in the following table for more information.

Tab	Function
Results	Displays the results of the test and any error conditions encountered.
Errors	Displays error conditions encountered, error codes, and the problem description.
Help	Describes the test and may indicate requirements for running the test.
Configuration	Displays your hardware configuration for the selected device.

	The Dell Diagnostics obtains configuration information for all devices from the system setup program, memory, and various internal tests, and it displays the information in the device list in the left pane of the screen. The device list may not display the names of all the components installed on your computer or all devices attached to your computer.
Parameters	Allows you to customize the test by changing the test settings.

4. When the tests are completed, if you are running the Dell Diagnostics from the *Drivers and Utilities* CD, remove the CD.
5. When the tests are completed, close the test screen to return to the **Main Menu** screen. To exit the Dell Diagnostics and restart the computer, close the **Main Menu** screen.

Dell Support Utility

The Dell Support Utility is installed on your computer and available from the Dell Support icon on the taskbar or from the **Start** button. Use this support utility for self-support information, software updates, and health scans of your computing environment.

Accessing the Dell Support Utility

Access the Dell Support Utility from the Dell Support icon on the taskbar or from the **Start** menu.

If the Dell Support icon does not appear in your taskbar:

1. Click the **Start** button and point to **Programs**.
2. Click **Dell Support** and point to **Dell Support Settings**.
3. Ensure that the **Show icon on the taskbar** option is checked.

 **NOTE:** If the Dell Support Utility is not available from the **Start** menu, go to support.dell.com and download the software.

The Dell Support Utility is customized for your computing environment.

The Dell Support icon in the taskbar functions differently when you click, double-click, or right-click the icon.

Clicking the Dell Support Icon

Click or right-click the  icon to perform the following tasks:

1. Check your computing environment
1. View the Dell Support Utility settings
1. Access the help file for the Dell Support Utility
1. View frequently asked questions
1. Learn more about the Dell Support Utility
1. Turn the Dell Support Utility off

Double-Clicking the Dell Support Icon

Double-click the  icon to manually check your computing environment, view frequently asked questions, access the help file for the Dell Support Utility, and view Dell Support settings.

For more information about the Dell Support Utility, click the question mark (?) at the top of the Dell Support screen.

Drive Problems

 **CAUTION:** Before you begin any of the procedures in this section, follow the safety instructions in the *Product Information Guide*.

Fill out the Diagnostics Checklist as you complete these checks. See [Diagnostics Checklist](#).

Ensure that Microsoft® Windows® recognizes the drive — Click the **Start** button and click **My Computer**. If the floppy, CD, or DVD drive, is not listed,

perform a full scan with your antivirus software to check for and remove viruses. Viruses can sometimes prevent Windows from recognizing the drive.

Test the drive —

- 1 Insert another floppy disk, CD, or DVD to eliminate the possibility that the original one is defective.
- 1 Insert a bootable floppy disk and restart the computer.

Clean the drive or disk — See [Cleaning Your Computer](#).

Ensure that the CD is snapped onto the spindle

Check the cable connections

Check for hardware incompatibilities — See [Software and Hardware Incompatibilities](#).

Run the Dell Diagnostics — See [Dell Diagnostics](#).

CD and DVD drive problems

 **NOTE:** High-speed CD or DVD drive vibration is normal and may cause noise, which does not indicate a defect in the drive or the CD or DVD.

 **NOTE:** Because of different regions worldwide and different disc formats, not all DVD titles work in all DVD drives.

Problems writing to a CD/DVD-RW drive

Close other programs — The CD/DVD-RW drive must receive a steady stream of data when writing. If the stream is interrupted, an error occurs. Try closing all programs before you write to the CD/DVD-RW.

Turn off Standby mode in Windows before writing to a CD/DVD-RW disc — See [Standby Mode](#) or search for the keyword *standby* in the Windows Help and Support Center for information on power management modes.

Change the write speed to a slower rate — See the help files for your CD or DVD creation software.

If you cannot eject the CD, CD-RW, DVD, or DVD+RW drive tray

1. Ensure that the computer is shut down.
2. Straighten a paper clip and insert one end into the eject hole at the front of the drive; push firmly until the tray is partially ejected.
3. Gently pull out the tray until it stops.

If you hear an unfamiliar scraping or grinding sound

- 1 Ensure that the sound is not caused by the program that is running.
- 1 Ensure that the disk or disc is inserted properly.

Hard drive problems

Allow the computer to cool before turning it on — A hot hard drive may prevent the operating system from starting. Try allowing the computer to return to room temperature before turning it on.

Run Check Disk —

1. Click the **Start** button and click **My Computer**.
 2. Right-click **Local Disk C:**.
 3. Click **Properties**.
 4. Click the **Tools** tab.
 5. Under **Error-checking**, click **Check Now**.
 6. Click **Scan for and attempt recovery of bad sectors**.
 7. Click **Start**.
-

E-Mail, Modem, and Internet Problems

 **CAUTION:** Before you begin any of the procedures in this section, follow the safety instructions in the *Product Information Guide*.

 **NOTE:** Connect the modem to an analog telephone jack only. The modem does not operate while it is connected to a digital telephone network.

Check the Microsoft Outlook® Express Security Settings — If you cannot open your e-mail attachments:

1. In Outlook Express, click **Tools**, click **Options**, and then click **Security**.
2. Click **Do not allow attachments** to remove the checkmark.

Check the telephone line connection

Check the telephone jack

Connect the modem directly to the telephone wall jack

Use a different telephone line —

1. Verify that the telephone line is connected to the jack on the modem. (The jack has either a green label or a connector-shaped icon next to it.)
1. Ensure that you hear a click when you insert the telephone line connector into the modem.
1. Disconnect the telephone line from the modem and connect it to a telephone. Listen for a dial tone.
1. If you have other telephone devices sharing the line, such as an answering machine, fax machine, surge protector, or line splitter, then bypass them and connect the modem directly to the telephone wall jack. If you are using a line that is 3 m (10 ft) or more in length, try a shorter one.

Run the Modem Helper diagnostics — Click the **Start** button, point to **All Programs** and then click **Modem Helper**. Follow the instructions on the screen to identify and resolve modem problems. (Modem Helper is not available on all computers.)

Verify that the modem is communicating with Windows —

1. Click the **Start** button and click **Control Panel**.
2. Click **Printers and Other Hardware**.
3. Click **Phone and Modem Options**.
4. Click the **Modems** tab.
5. Click the COM port for your modem.
6. Click **Properties**, click the **Diagnostics** tab, and then click **Query Modem** to verify that the modem is communicating with Windows.

If all commands receive responses, the modem is operating properly.

Ensure that you are connected to the Internet — Ensure that you have subscribed to an Internet provider. With the Outlook Express e-mail program open, click **File**. If **Work Offline** has a checkmark next to it, click the checkmark to remove it and connect to the Internet. For help, contact your Internet service provider.

Scan the computer for spyware — If you are experiencing slow computer performance, you frequently receive pop-up advertisements, or you are having problems connecting to the Internet, your computer might be infected with spyware. Use an anti-virus program that includes anti-spyware protection (your program may require an upgrade) to scan the computer and remove spyware. For more information, go to support.dell.com and search for the keyword *spyware*.

Error Messages

Fill out the Diagnostics Checklist as you complete these checks. See [Diagnostics Checklist](#).

 **CAUTION:** Before you begin any of the procedures in this section, follow the safety instructions in the *Product Information Guide*.

If the message is not listed, see the documentation for the operating system or the program that was running when the message appeared.

Auxiliary device failure — The touch pad, track stick, or external mouse may be faulty. For an external mouse, check the cable connection. Enable the **Pointing Device** option in the system setup program. If the problem persists, contact Dell. See [Contacting Dell](#).

Bad command or file name — Ensure that you have spelled the command correctly, put spaces in the proper place, and used the correct pathname.

Cache disabled due to failure — The primary cache internal to the microprocessor has failed. Contact Dell. [Contacting Dell](#).

CD drive controller failure — The CD drive does not respond to commands from the computer. See [Dell Support Utility](#).

Data error — The hard drive cannot read the data. See [Dell Support Utility](#).

Decreasing available memory — One or more memory modules may be faulty or improperly seated. Reinstall the memory modules and, if necessary, replace them. See [Memory](#).

Disk C: failed initialization — The hard drive failed initialization. Run the hard drive tests in the Dell Diagnostics. See [Dell Diagnostics](#).

Drive not ready — The operation requires a hard drive in the bay before it can continue. Install a hard drive in the hard drive bay. See [Hard Drive](#).

Error reading PCMCIA card — The computer cannot identify the ExpressCard. Reinsert the card or try another card. See [Using Cards](#).

Extended memory size has changed — The amount of memory recorded in NVRAM does not match the memory installed in the computer. Restart the computer. If the error appears again, contact Dell. See [Contacting Dell](#).

The file being copied is too large for the destination drive — The file that you are trying to copy is too large to fit on the disk, or the disk is too full. Try copying the file to a different disk or use a larger capacity disk.

A filename cannot contain any of the following characters: \ / : * ? " < > | — Do not use these characters in filenames.

Gate A20 failure — A memory module may be loose. Reinstall the memory modules and, if necessary, replace them. See [Memory](#).

General failure — The operating system is unable to carry out the command. The message is usually followed by specific information—for example, **Printer out of paper**. Take the appropriate action.

Hard-disk drive configuration error — The computer cannot identify the drive type. Shut down the computer, remove the hard drive (see [Hard Drive](#)), and boot the computer from a CD. Then shut down the computer, reinstall the hard drive, and restart the computer. Run the Hard-Disk Drive tests in the Dell Diagnostics. See [Dell Diagnostics](#).

Hard-disk drive controller failure 0 — The hard drive does not respond to commands from the computer. Shut down the computer, remove the hard drive (see [Hard Drive](#)), and boot the computer from a CD. Then shut down the computer, reinstall the hard drive, and restart the computer. If the problem persists, try another drive. Run the Hard-Disk Drive tests in the Dell Diagnostics. See [Dell Diagnostics](#).

Hard-disk drive failure — The hard drive does not respond to commands from the computer. Shut down the computer, remove the hard drive (see [Hard Drive](#)), and boot the computer from a CD. Then shut down the computer, reinstall the hard drive, and restart the computer. If the problem persists, try another drive. Run the Hard-Disk Drive tests in the Dell Diagnostics. See [Dell Diagnostics](#).

Hard-disk drive read failure — The hard drive may be defective. Shut down the computer, remove the hard drive (see [Hard Drive](#)), and boot the computer from a CD. Then shut down the computer, reinstall the hard drive, and restart the computer. If the problem persists, try another drive. Run the Hard-Disk Drive tests in the Dell Diagnostics. See [Dell Diagnostics](#).

Insert bootable media — The operating system is trying to boot to a nonbootable CD. Insert a bootable CD.

Invalid configuration information-please run System Setup Program — The system configuration information does not match the hardware configuration. The message is most likely to occur after a memory module is installed. Correct the appropriate options in the system setup program. See [System Setup Program](#).

Keyboard clock line failure — For external keyboards, check the cable connection. Run the Keyboard Controller test in the Dell Diagnostics. See [Dell Diagnostics](#).

Keyboard controller failure — For external keyboards, check the cable connection. Restart the computer, and avoid touching the keyboard or the mouse during the boot routine. Run the Keyboard Controller test in the Dell Diagnostics. See [Dell Diagnostics](#).

Keyboard data line failure — For external keyboards, check the cable connection. Run the Keyboard Controller test in the Dell Diagnostics. See [Dell Diagnostics](#).

Keyboard stuck key failure — For external keyboards or keypads, check the cable connection. Restart the computer, and avoid touching the keyboard or keys during the boot routine. Run the Stuck Key test in the Dell Diagnostics. See [Dell Diagnostics](#).

Memory address line failure at address, read value expecting value — A memory module may be faulty or improperly seated. Reinstall the memory modules and, if necessary, replace them (see [Memory](#)).

Memory allocation error — The software you are attempting to run is conflicting with the operating system, another program, or a utility. Shut down the computer, wait 30 seconds, and then restart it. Try to run the program again. If the error message still appears, see the software documentation.

Memory data line failure at address, read value expecting value — A memory module may be faulty or improperly seated. Reinstall the memory modules and, if necessary, replace them (see [Memory](#)).

Memory double word logic failure at address, read value expecting value — A memory module may be faulty or improperly seated. Reinstall the memory modules and, if necessary, replace them (see [Memory](#)).

Memory odd/even logic failure at address, read value expecting value — A memory module may be faulty or improperly seated. Reinstall the memory modules and, if necessary, replace them (see [Memory](#)).

Memory write/read failure at address, read value expecting value — A memory module may be faulty or improperly seated. Reinstall the memory modules and, if necessary, replace them (see [Memory](#)).

No boot device available — The computer cannot find the hard drive. If the hard drive is your boot device, ensure that the drive is installed, properly seated, and partitioned as a boot device.

No boot sector on hard drive — The operating system may be corrupted. Contact Dell. See [Contacting Dell](#).

No timer tick interrupt — A chip on the system board may be malfunctioning. Run the System Set tests in the Dell Diagnostics. See [Dell Diagnostics](#).

Not enough memory or resources. Exit some programs and try again — You have too many programs open. Close all windows and open the program that you want to use.

Operating system not found — Reinstall the hard drive (see [Hard Drive](#)). If the problem persists, contact Dell. See [Contacting Dell](#).

Optional ROM bad checksum — The optional ROM apparently failed. Contact Dell. See [Contacting Dell](#).

A required .DLL file was not found — The program that you are trying to open is missing an essential file. Remove and then reinstall the program.

1. Click the **Start** button and click **Control Panel**.
2. Click **Add or Remove Programs**.
3. Select the program you want to remove.
4. Click **Remove** or **Change/Remove** and follow the prompts on the screen.
5. See the program documentation for installation instructions.

Sector not found — The operating system cannot locate a sector on the hard drive. You may have a defective sector or corrupted FAT on the hard drive. Run the Windows error-checking utility to check the file structure on the hard drive. See the Windows Help and Support Center for instructions. To access the Help and Support Center, see [Windows Help and Support Center](#). If a large number of sectors are defective, back up the data (if possible), and then reformat the hard drive.

Seek error — The operating system cannot find a specific track on the hard drive.

Shutdown failure — A chip on the system board may be malfunctioning. Run the System Set tests in the Dell Diagnostics (see [Dell Diagnostics](#)).

Time-of-day clock lost power — System configuration settings are corrupted. Connect your computer to an electrical outlet to charge the battery. If the problem persists, try to restore the data by entering the system setup program. Then immediately exit the program. See [System Setup Program](#). If the message reappears, contact Dell. See [Contacting Dell](#).

Time-of-day clock stopped — The reserve battery that supports the system configuration settings may require replacing. Contact Dell. See [Contacting Dell](#).

Time-of-day not set-please run the System Setup program — The time or date stored in the system setup program does not match the system clock. Correct the settings for the **Date** and **Time** options. See [System Setup Program](#).

Timer chip counter 2 failed — A chip on the system board may be malfunctioning. Run the System Set tests in the Dell Diagnostics. See [Dell Diagnostics](#).

Unexpected interrupt in protected mode — The keyboard controller may be malfunctioning, or a memory module may be loose. Run the System Memory tests and the Keyboard Controller test in the Dell Diagnostics. See [Dell Diagnostics](#).

x:\ is not accessible. The device is not ready — Insert a disk into the drive and try again.

Warning: Battery is critically low — The battery is running out of charge. Replace the battery, or connect the computer to an electrical outlet. Otherwise, activate hibernate mode or shut down the computer.

ExpressCard Problems

 **CAUTION:** Before you begin any of the procedures in this section, follow the safety instructions in the *Product Information Guide*.

 **NOTE:** The ExpressCard slot does not support PC Cards.

Check the ExpressCard — Ensure that the ExpressCard is properly inserted into the connector.

Ensure that the card is recognized by Windows — Double-click the **Safely Remove Hardware** icon in the Windows taskbar. Ensure that the card is listed.

If you have problems with a Dell-provided ExpressCard — Contact Dell. See [Contacting Dell](#).

If you have problems with an ExpressCard not provided by Dell — Contact the ExpressCard manufacturer.

IEEE 1394 Device Problems

 **CAUTION:** Before you begin any of the procedures in this section, follow the safety instructions in the *Product Information Guide*.

Ensure that the IEEE 1394 device is recognized by Windows —

1. Click the **Start** button and click **Control Panel**.
2. Click **Printers and Other Hardware**.

If your IEEE 1394 device is listed, Windows recognizes the device.

If you have problems with a Dell-provided IEEE 1394 device —

If you have problems with an IEEE 1394 device not provided by Dell —

Contact Dell (see [Contacting Dell](#)) or the IEEE 1394 device manufacturer.

Ensure that the IEEE 1394 device is properly inserted into the connector

Keyboard Problems

 **CAUTION:** Before you begin any of the procedures in this section, follow the safety instructions in the *Product Information Guide*.

Fill out the Diagnostics Checklist (see [Diagnostics Checklist](#)) as you perform the various checks.

External Keyboard problems

 **NOTE:** When you attach an external keyboard, the integrated keyboard remains fully functional.

Check the keyboard cable — Shut down the computer. Disconnect the keyboard cable and check it for damage, and firmly reconnect the cable.

If you are using a keyboard extension cable, disconnect it and connect the keyboard directly to the computer.

Check the external keyboard —

1. Shut down the computer, wait 1 minute, and turn it on again.
2. Verify that the numbers, capitals, and scroll lock lights on the keyboard blink during the boot routine.
3. From the Windows desktop, click the **Start** button, point to **All Programs**→ **Accessories**, and then click **Notepad**.
4. Type some characters on the external keyboard and verify that they appear on the display.

If you cannot verify these steps, you may have a defective external keyboard.

To verify that the problem is with the external keyboard, check the integrated keyboard —

1. Shut down the computer.
2. Disconnect the external keyboard.
3. Turn on the computer.
4. From the Windows desktop, click the **Start** button, point to **All Programs**→ **Accessories**, and click **Notepad**.
5. Type some characters on the internal keyboard and verify that they appear on the display.

If the characters appear now but did not with the external keyboard, you may have a defective external keyboard. Contact Dell. See [Contacting Dell](#).

Run the keyboard diagnostics tests — Run the PC-AT Compatible Keyboards tests in the Dell Diagnostics. See [Dell Diagnostics](#). If the tests indicate a defective external keyboard, contact Dell. See [Contacting Dell](#).

Unexpected characters

Disable the numeric keypad — Press <Num Lk> to disable the numeric keypad if numbers are displayed instead of letters. Verify that the numbers lock light is not lit.

Lockups and Software Problems

 **CAUTION:** Before you begin any of the procedures in this section, follow the safety instructions in the *Product Information Guide*.

The computer does not start up

Ensure that the AC adapter is firmly connected to the computer and to the electrical outlet

The computer stops responding

 **NOTICE:** You might lose data if you are unable to perform an operating system shutdown.

Turn the computer off — If you are unable to get a response by pressing a key on your keyboard or moving your mouse, press and hold the power button for at least 8 to 10 seconds until the computer turns off. Then restart your computer.

A program stops responding or crashes repeatedly

 **NOTE:** Software usually includes installation instructions in its documentation or on a floppy disk or CD.

End the program —

1. Press <Ctrl><Shift><Esc> simultaneously.
2. Click **Task Manager**.
3. Click the program that is no longer responding.
4. Click **End Task**.

Check the software documentation — If necessary, uninstall and then reinstall the program.

A program is designed for an earlier Microsoft® Windows® operating system

Run the Program Compatibility Wizard — The Program Compatibility Wizard configures a program so it runs in an environment similar to non-Windows XP operating system environments.

1. Click the **Start** button, point to **All Programs**→ **Accessories**, and then click **Program Compatibility Wizard**.
2. In the welcome screen, click **Next**.
3. Follow the instructions on the screen.

A solid blue screen appears

Turn the computer off — If you are unable to get a response by pressing a key on your keyboard or moving your mouse, press and hold the power button for at least 8 to 10 seconds until the computer turns off. Then restart your computer.

Other software problems

Check the software documentation or contact the software manufacturer for troubleshooting information —

1. Ensure that the program is compatible with the operating system installed on your computer.
1. Ensure that your computer meets the minimum hardware requirements needed to run the software. See the software documentation for information.
1. Ensure that the program is installed and configured properly.
1. Verify that the device drivers do not conflict with the program.
1. If necessary, uninstall and then reinstall the program.

Back up your files immediately

Use a virus-scanning program to check the hard drive, floppy disks, or CDs

Save and close any open files or programs and shut down your computer through the Start menu

Scan the computer for spyware — If you are experiencing slow computer performance, you frequently receive pop-up advertisements, or you are having problems connecting to the Internet, your computer might be infected with spyware. Use an anti-virus program that includes anti-spyware protection (your program may require an upgrade) to scan the computer and remove spyware. For more information, go to support.dell.com and search for the keyword *spyware*.

Run the Dell Diagnostics — See [Dell Diagnostics](#). If all tests run successfully, the error condition is related to a software problem.

Memory Problems

Fill out the Diagnostics Checklist (see [Diagnostics Checklist](#)) as you complete these checks.

 **CAUTION:** Before you begin any of the procedures in this section, follow the safety instructions in the *Product Information Guide*.

If you receive an insufficient memory message —

1. Save and close any open files and exit any open programs you are not using to see if that resolves the problem.
1. See the software documentation for minimum memory requirements. If necessary, install additional memory. See [Memory](#).
1. Reseat the memory modules to ensure that your computer is successfully communicating with the memory. See [Memory](#).
1. Run the Dell Diagnostics. See [Dell Diagnostics](#).

If you experience other memory problems —

- 1 Reseat the memory modules to ensure that your computer is successfully communicating with the memory (see [Memory](#)).
 - 1 Ensure that you are following the memory installation guidelines. See [Memory](#).
 - 1 Run the Dell Diagnostics. See [Dell Diagnostics](#).
-

Network Problems

Fill out the Diagnostics Checklist (see [Diagnostics Checklist](#)) as you complete these checks.

 **CAUTION:** Before you begin any of the procedures in this section, follow the safety instructions in the *Product Information Guide*.

General

Check the network cable connector — Ensure that the network cable is firmly inserted into both the network connector on the back of the computer and the network jack.

Check the network lights on the network connector — No light indicates that no network communication exists. Replace the network cable.

Restart the computer and log on to the network again.

Check your network settings — Contact your network administrator or the person who set up your network to verify that your network settings are correct and that the network is functioning.

Mobile Broadband Network

 **NOTE:** The Dell Mobile Broadband Card Utility user's guide is located under Help and Support. You can also download the user's guide from support.dell.com.

 **NOTE:** The  icon appears in the notification area if the computer has a Dell Mobile Broadband card installed. Double-click the icon to launch the utility.

Cannot connect — The Dell Mobile Broadband Card must be activated on the network in order to connect. Position the mouse over the  icon in the notification area to read the status of the connection. If the status indicates the mobile broadband card is not activated, see [Activate your Mobile Broadband card](#) for more information. If problems persist, contact your Mobile Broadband service carrier for details on your plan.

Check your Mobile Broadband network service — Contact your Mobile Broadband service carrier to verify coverage plan and supported services.

Check the status in the Dell Mobile Broadband Card Utility — Click the  icon in the taskbar to launch the utility. Check the status in the main window:

- 1 **No card detected** – Restart the computer and launch the utility again.
- 1 **Wireless Disabled** – Ensure that the Dell Wi-Fi Catcher™ switch is in the "on" position. Additionally, right-click the  icon and ensure that the switch is enabled.
- 1 **Searching** – The Dell Mobile Broadband Card Utility has not yet located a Mobile Broadband network. If the searching state persists, ensure that the signal strength is adequate.
- 1 **No service** – The Dell Mobile Broadband Card Utility did not locate a Mobile Broadband network. Ensure that the signal strength is adequate. Restart the Dell wireless utility or contact your Mobile Broadband network provider.
- 1 **Check your WWAN service** – Contact your Mobile Broadband network service provider to verify coverage plan and supported services.

Activate your Mobile Broadband card — Before you connect to the Internet, you must activate the Mobile Broadband service through your cellular service provider. For instructions and for additional information about using the Dell Mobile Broadband Card Utility, see the user's guide available through the Windows Help and Support Center. To access the Help and Support Center, see [Windows Help and Support Center](#). The user's guide is also available on the Dell Support website at support.dell.com and on the CD included with your Mobile Broadband card if you purchased the card separately from your computer.

Power Problems

Fill out the Diagnostics Checklist (see [Diagnostics Checklist](#)) as you complete these checks.

 **CAUTION:** Before you begin any of the procedures in this section, follow the safety instructions in the *Product Information Guide*.

Check the power light — When the power light is lit or blinking, the computer has power. If the power light is blinking, the computer is in standby mode—press the power button to exit standby mode. If the light is off, press the power button to turn on the computer.

Charge the battery — The battery charge may be depleted.

1. Reinstall the battery.
2. Use the AC adapter to connect the computer to an electrical outlet.
3. Turn on the computer.

 **NOTE:** Battery operating time (the time the battery can operate the computer) decreases over time. Depending on how often the battery is used and the conditions under which it is used, you may need to purchase a new battery during the life of your computer.

Check the battery status light — If the battery status light flashes orange or is a steady orange the battery charge is low or depleted. Connect the computer to an electrical outlet.

If the battery status light flashes green and orange, the battery is too hot to charge. Shut down the computer, disconnect the computer from the electrical outlet, and then let the battery and computer cool to room temperature.

If the battery status light rapidly flashes orange, the battery may be defective. Contact Dell. See [Contacting Dell](#).

Check the battery temperature — If the battery temperature is below 0°C (32°F), the computer will not start up.

Test the electrical outlet — Ensure that the electrical outlet is working by testing it with another device, such as a lamp.

Check the AC adapter — Check the AC adapter cable connections. If the AC adapter has a light, ensure that the light is on.

Connect the computer directly to an electrical outlet — Bypass power protection devices, power strips, and the extension cable to verify that the computer turns on.

Eliminate possible interference — Turn off nearby fans, fluorescent lights, halogen lamps, or other appliances.

Adjust the power properties — See [Configuring Power Management Settings](#).

Reseat the memory modules — If the computer power light turns on but the display remains blank, reinstall the memory modules. See [Memory](#).

Ensuring Sufficient Power for Your Computer

Your computer is designed to use the 130-W AC adapter; for optimum system performance, you should always use this adapter.

If you use less-powerful AC adapters, you may receive a **WARNING** message.

Docking Power Considerations

Due to the extra power consumption when a computer is docked to the Dell D/Dock, normal computer operation is not possible on battery power alone. Ensure that the AC adapter is connected to your computer when the computer is docked to the Dell D/Dock.

Docking While the Computer Is Running

If a computer is connected to the Dell D/Dock or Dell D/Port while the computer is running, presence of the docking device is ignored until the AC adapter is connected to the computer.

AC Power Loss While the Computer Is Docked

If a computer loses AC power while docked to the Dell D/Dock or Dell D/Port, the computer immediately goes into low-performance mode.

Printer Problems

Fill out the Diagnostics Checklist (see [Diagnostics Checklist](#)) as you complete these checks.

 **CAUTION:** Before you begin any of the procedures in this section, follow the safety instructions in the *Product Information Guide*.

 **NOTE:** If you need technical assistance for your printer, contact the printer's manufacturer.

Ensure that the printer is turned on

Check the printer cable connections —

1. See the printer documentation for cable connection information.
1. Ensure that the printer cables are securely connected to the printer and the computer.

Test the electrical outlet —

Ensure that the electrical outlet is working by testing it with another device, such as a lamp.

Verify that the printer is recognized by Windows —

1. Click the **Start** button, click **Control Panel**, and then click **Printers and Other Hardware**.
2. Click **View installed printers or fax printers**.
If the printer is listed, right-click the printer icon.
3. Click **Properties** and click the **Ports** tab. For a parallel printer, ensure that the **Print to the following port(s)**: setting is **LPT1 (Printer Port)**. For a USB printer, ensure that the **Print to the following port(s)**: setting is **USB**.

Reinstall the printer driver —

See the printer documentation for instructions

Scanner Problems

 **CAUTION:** Before you begin any of the procedures in this section, follow the safety instructions in the *Product Information Guide*.

 **NOTE:** If you need technical assistance for your scanner, contact the scanner's manufacturer.

Check the scanner documentation — See the scanner documentation for setup and troubleshooting information.

Unlock the scanner — Ensure that your scanner is unlocked if it has a locking tab or button.

Restart the computer and try the scanner again.

Check the cable connections —

1. See the scanner documentation for cable connection information.
1. Ensure that the scanner cables are securely connected to the scanner and the computer.

Verify that the scanner is recognized by Microsoft Windows —

1. Click the **Start** button, click **Control Panel**, and then click **Printers and Other Hardware**.
2. Click **Scanners and Cameras**.

If your scanner is listed, Windows recognizes the scanner.

Reinstall the scanner driver —

See the scanner documentation for instructions.

Sound and Speaker Problems

Fill out the Diagnostics Checklist (see [Diagnostics Checklist](#)) as you complete these checks.

 **CAUTION:** Before you begin any of the procedures in this section, follow the safety instructions in the *Product Information Guide*.

No sound from integrated speakers

Adjust the Windows volume control — Double-click the speaker icon in the lower-right corner of your screen. Ensure that the volume is turned up and that the sound is not muted. Adjust the volume, bass, or treble controls to eliminate distortion.

Adjust the volume using keyboard shortcuts — Press <Fn><End> to disable (mute) or reenable the integrated speakers.

Reinstall the sound (audio) driver — See [Reinstalling Drivers and Utilities](#).

No sound from external speakers

Ensure that the subwoofer and the speakers are turned on — See the setup diagram supplied with the speakers. If your speakers have volume controls, adjust the volume, bass, or treble to eliminate distortion.

Adjust the Windows volume control — Click or double-click the speaker icon in the lower-right corner of your screen. Ensure that the volume is turned up and that the sound is not muted.

Disconnect headphones from the headphone connector — Sound from the speakers is automatically disabled when headphones are connected to the computer's front-panel headphone connector.

Test the electrical outlet — Ensure that the electrical outlet is working by testing it with another device, such as a lamp.

Eliminate possible interference — Turn off nearby fans, fluorescent lights, or halogen lamps to check for interference.

Reinstall the audio driver — See [Reinstalling Drivers and Utilities](#).

Run the Dell Diagnostics — See [Dell Diagnostics](#).

 **NOTE:** The volume control in some MP3 players overrides the Windows volume setting. If you have been listening to MP3 songs, ensure that you did not turn the player volume down or off.

No sound from headphones

Check the headphone cable connection — Ensure that the headphone cable is securely inserted into the headphone connector (see [audio connectors](#)).

Adjust the Windows volume control — Click or double-click the speaker icon in the lower-right corner of your screen. Ensure that the volume is turned up and that the sound is not muted.

Touch Pad or Mouse Problems

Check the touch pad settings —

1. Click the **Start** button, click **Control Panel**, and then click **Printers and Other Hardware**.
2. Click **Mouse**.
3. Try adjusting the settings.

Check the mouse cable — Shut down the computer. Disconnect the mouse cable, check it for damage, and firmly reconnect the cable.

If you are using a mouse extension cable, disconnect it and connect the mouse directly to the computer.

To verify that the problem is with the mouse, check the touch pad —

1. Shut down the computer.
2. Disconnect the mouse.
3. Turn on the computer.
4. At the Windows desktop, use the touch pad to move the cursor around, select an icon, and open it.

If the touch pad operates correctly, the mouse may be defective.

Check the system setup program settings — Verify that the system setup program lists the correct device for the pointing device option. (The computer automatically recognizes a USB mouse without making any setting adjustments.)

Test the mouse controller — To test the mouse controller (which affects pointer movement) and the operation of the touch pad or mouse buttons, run the Mouse test in the **Pointing Devices** test group in the Dell Diagnostics. See [Dell Diagnostics](#).

Reinstall the touch pad driver — See [Reinstalling Drivers and Utilities](#).

Video and Display Problems

Fill out the Diagnostics Checklist (see [Diagnostics Checklist](#)) as you complete these checks.

 **CAUTION:** Before you begin any of the procedures in this section, follow the safety instructions in the *Product Information Guide*.

If the display is blank

 **NOTE:** If you are using a program that requires a higher resolution than your computer supports, it is recommended that you attach an external monitor to your computer.

Check the battery — If you are using a battery to power your computer, the battery charge may be depleted. Connect the computer to an electrical outlet using the AC adapter, and turn on the computer.

Test the electrical outlet — Ensure that the electrical outlet is working by testing it with another device, such as a lamp.

Check the AC adapter — Check the AC adapter cable connections. If the AC adapter has a light, ensure that the light is on.

Connect the computer directly to an electrical outlet — Bypass power protection devices, power strips, and the extension cable to verify that the computer turns on.

Adjust the power properties — Search for the keyword *standby* in the Windows Help and Support Center. To access the Help and Support Center, see [Windows Help and Support Center](#).

Switch the video image — If your computer is attached to an external monitor, press <Fn><F8> to switch the video image to the display.

If the display is difficult to read

Adjust the brightness — Press <Fn> and the up- or down-arrow key

Move the external subwoofer away from the computer or monitor — If your external speaker system includes a subwoofer, ensure that the subwoofer is at least 60 cm (2 ft) away from the computer or external monitor.

Eliminate possible interference — Turn off nearby fans, fluorescent lights, halogen lamps, or other appliances.

Rotate the computer to face a different direction — Eliminate sunlight glare, which can cause poor picture quality.

Adjust the Windows display settings —

1. Click the **Start** button and then click **Control Panel**.
2. Click **Appearance and Themes**.
3. Click the area you want to change or click the **Display** icon.
4. Try different settings for **Color quality** and **Screen resolution**.

Run the Video diagnostics tests — If no error message appears and you still have a display problem, but the display is not completely blank, run the **Video** device group in the Dell Diagnostics. Then contact Dell. See [Contacting Dell](#).

See "Error Messages" — If an error message appears, see [Error Messages](#).

If only part of the display is readable

Connect an external monitor —

1. Shut down your computer and connect an external monitor to the computer.
2. Turn on the computer and the monitor and adjust the monitor brightness and contrast controls.

If the external monitor works, the computer display or video controller may be defective. Contact Dell. See [Contacting Dell](#).